

doccia

pannelli doccia

Sono disponibili, su richiesta, per quantitativi, anche tutte le altre maniglie di nostra produzione. Per clienti OEM sono disponibili anche personalizzazioni.

On request, for quantities, are also available all the other handles of our production. For OEM customers customizations are available.

Sont disponibles, sur demande pour des quantités, aussi tous les autres leviers de notre production. Pour les clients OEM sont disponibles les personnalisations.

Sie sind auf Anfrage erhältlich für Mengen, auch alle anderen Hebel unserer Produktion. Für OEM-Kunden verfügbar sind Anpassungen.

Están disponibles, a petición de las cantidades, también todos los manetas se encarga de la producción. Para los clientes de OEM son disponibles personalizaciones.

finiture disponibili

available finishes

finition disponibles

verfügbare Farben

acabados disponibles

10 Cromo - Chrome - Chrome
Chrom - Cromo



Miscelatore **monocomando** 1/2" da incasso completo per pannelli doccia con deviatore a **2 uscite** e valvole di non ritorno.

Complete 1/2" concealed thermostatic mixer for shower with ceramic discs diverter, 2 outlets and stop function.

Mitigeur thermostatique 1/2" à encastrer complet pour douche avec inverseur à disques en céramique, 2 sorties et fonction de stop.

Komplett Unterputz 1/2" Thermostat-Mischer, mit Keramik 2-Wegeumsteller mit Stop-Position.

Mezclador termostático 1/2" empotrable completo para ducha con desviador a discos cerámicos, 2 salidas con stop.

Miscelatore **monocomando** 1/2" da incasso completo per pannelli doccia con deviatore a **2 uscite** e valvole di non ritorno.

Complete 1/2" concealed thermostatic mixer for shower with ceramic discs diverter, 2 outlets and stop function.

Mitigeur thermostatique 1/2" à encastrer complet pour douche avec inverseur à disques en céramique, 2 sorties et fonction de stop.

Komplett Unterputz 1/2" Thermostat-Mischer, mit Keramik 2-Wegeumsteller mit Stop-Position.

Mezclador termostático 1/2" empotrable completo para ducha con desviador a discos cerámicos, 2 salidas con stop.

Miscelatore **termostatico** 1/2" da incasso completo per pannelli doccia con deviatore a **2 uscite** e valvole di non ritorno.

Complete 1/2" concealed thermostatic mixer for shower with ceramic discs diverter, 2 outlets and stop function.

Mitigeur thermostatique 1/2" à encastrer complet pour douche avec inverseur à disques en céramique, 2 sorties et fonction de stop.

Komplett Unterputz 1/2" Thermostat-Mischer, mit Keramik 2-Wegeumsteller mit Stop-Position.

Mezclador termostático 1/2" empotrable completo para ducha con desviador a discos cerámicos, 2 salidas con stop.

Miscelatore **termostatico** 1/2" da incasso completo per pannelli doccia con deviatore a **2 uscite** e valvole di non ritorno.

Complete 1/2" concealed thermostatic mixer for shower with ceramic discs diverter, 2 outlets and stop function.

Mitigeur thermostatique 1/2" à encastrer complet pour douche avec inverseur à disques en céramique, 2 sorties et fonction de stop.

Komplett Unterputz 1/2" Thermostat-Mischer, mit Keramik 2-Wegeumsteller mit Stop-Position.

Mezclador termostático 1/2" empotrable completo para ducha con desviador a discos cerámicos, 2 salidas con stop.

Miscelatore **termostatico** 1/2" da incasso completo per pannelli doccia con deviatore a **2 uscite** e valvole di non ritorno.

Complete 1/2" concealed thermostatic mixer for shower with ceramic discs diverter, 2 outlets and stop function.

Mitigeur thermostatique 1/2" à encastrer complet pour douche avec inverseur à disques en céramique, 2 sorties et fonction de stop.

Komplett Unterputz 1/2" Thermostat-Mischer, mit Keramik 2-Wegeumsteller mit Stop-Position.

Mezclador termostático 1/2" empotrable completo para ducha con desviador a discos cerámicos, 2 salidas con stop.

Miscelatore **termostatico** 1/2" da incasso completo per pannelli doccia con deviatore a **2 uscite** e valvole di non ritorno.

Complete 1/2" concealed thermostatic mixer for shower with ceramic discs diverter, 2 outlets and stop function.

Mitigeur thermostatique 1/2" à encastrer complet pour douche avec inverseur à disques en céramique, 2 sorties et fonction de stop.

Komplett Unterputz 1/2" Thermostat-Mischer, mit Keramik 2-Wegeumsteller mit Stop-Position.

Mezclador termostático 1/2" empotrable completo para ducha con desviador a discos cerámicos, 2 salidas con stop.

Miscelatore **termostatico** 1/2" da incasso completo per pannelli doccia con deviatore a **2 uscite** e valvole di non ritorno.

Complete 1/2" concealed thermostatic mixer for shower with ceramic discs diverter, 2 outlets and stop function.

Mitigeur thermostatique 1/2" à encastrer complet pour douche avec inverseur à disques en céramique, 2 sorties et fonction de stop.

Komplett Unterputz 1/2" Thermostat-Mischer, mit Keramik 2-Wegeumsteller mit Stop-Position.

Mezclador termostático 1/2" empotrable completo para ducha con desviador a discos cerámicos, 2 salidas con stop.

Miscelatore **termostatico** 1/2" da incasso completo per pannelli doccia con deviatore a **2 uscite** e valvole di non ritorno.

Complete 1/2" concealed thermostatic mixer for shower with ceramic discs diverter, 2 outlets and stop function.

Mitigeur thermostatique 1/2" à encastrer complet pour douche avec inverseur à disques en céramique, 2 sorties et fonction de stop.

Komplett Unterputz 1/2" Thermostat-Mischer, mit Keramik 2-Wegeumsteller mit Stop-Position.

Mezclador termostático 1/2" empotrable completo para ducha con desviador a discos cerámicos, 2 salidas con stop.

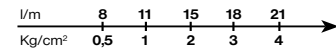

10 € 140,00 ■ box = 16 pz

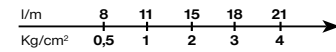

10 € 155,00 ■ box = 16 pz

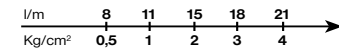

10 € 199,00 ■ box = 16 pz

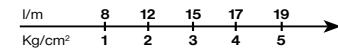

10 € 214,00 ■ box = 16 pz

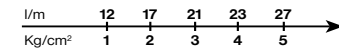

10 € 275,00 ■ box = 16 pz

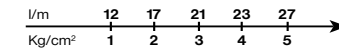

10 € 255,00 ■ box = 16 pz

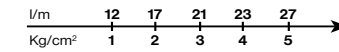

10 € 255,00 ■ box = 16 pz

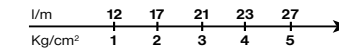

10 € 345,00 ■ box = 16 pz

4027V7

proxima

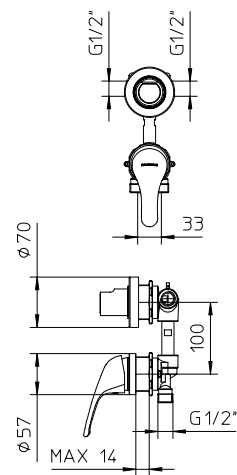

4827V7

pin

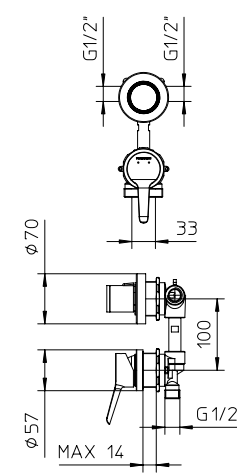

950112

proxima

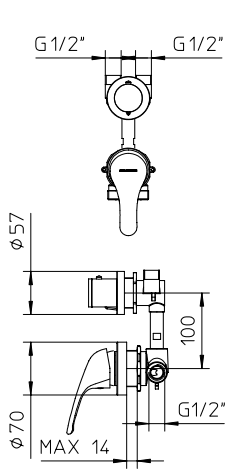

960112

pin

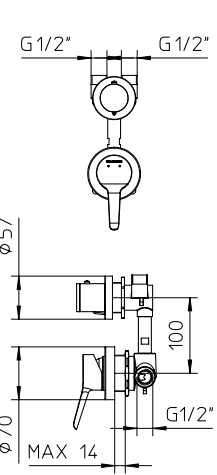

962439

digit

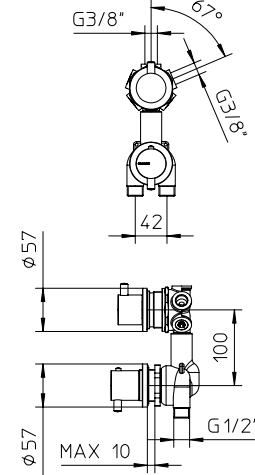

112439

digit abs

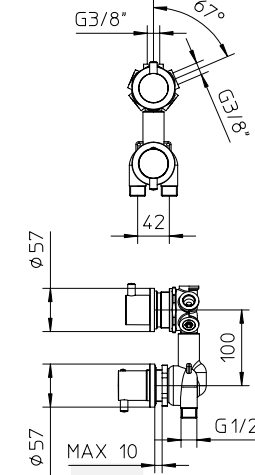

952439

maranello abs

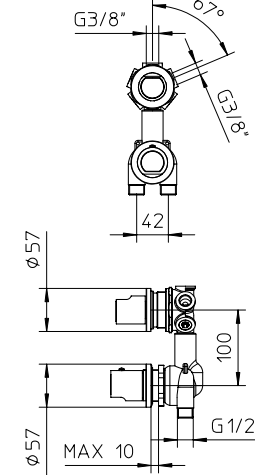

412439

track

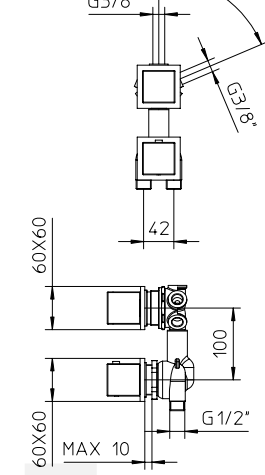

Miscelatore **termostatico** 3/4" da incasso completo per pannelli doccia con deviatore a **2 uscite** e valvole di non ritorno.

Complete 1/2" concealed thermostatic mixer for shower with ceramic discs diverter, 2 outlets and stop function.

Mitigeur thermostatique 1/2" à encastrer complet pour douche avec inverseur à disques en céramique, 2 sorties et fonction de stop.

Komplett Unterputz 1/2" Thermostat-Mischer, mit Keramik 2-Wegeumsteller mit Stop-Position.

Mezclador termostático 1/2" empotrable completo para ducha con desviador a discos cerámicos, 2 salidas con stop.

Miscelatore **termostatico** 3/4" da incasso completo per pannelli doccia con deviatore a **2 uscite** e valvole di non ritorno.

Complete 1/2" concealed thermostatic mixer for shower with ceramic discs diverter, 2 outlets and stop function.

Mitigeur thermostatique 1/2" à encastrer complet pour douche avec inverseur à disques en céramique, 2 sorties et fonction de stop.

Komplett Unterputz 1/2" Thermostat-Mischer, mit Keramik 2-Wegeumsteller mit Stop-Position.

Mezclador termostático 1/2" empotrable completo para ducha con desviador a discos cerámicos, 2 salidas con stop.

Miscelatore **termostatico** 3/4" da incasso completo per pannelli doccia con deviatore a **2 uscite** e valvole di non ritorno.

Complete 1/2" concealed thermostatic mixer for shower with ceramic discs diverter, 2 outlets and stop function.

Mitigeur thermostatique 1/2" à encastrer complet pour douche avec inverseur à disques en céramique, 2 sorties et fonction de stop.

Komplett Unterputz 1/2" Thermostat-Mischer, mit Keramik 2-Wegeumsteller mit Stop-Position.

Mezclador termostático 1/2" empotrable completo para ducha con desviador a discos cerámicos, 2 salidas con stop.

Miscelatore **termostatico** 3/4" da incasso completo per pannelli doccia con deviatore a **2 uscite** e valvole di non ritorno.

Complete 1/2" concealed thermostatic mixer for shower with ceramic discs diverter, 2 outlets and stop function.

Mitigeur thermostatique 1/2" à encastrer complet pour douche avec inverseur à disques en céramique, 2 sorties et fonction de stop.

Komplett Unterputz 1/2" Thermostat-Mischer, mit Keramik 2-Wegeumsteller mit Stop-Position.

Mezclador termostático 1/2" empotrable completo para ducha con desviador a discos cerámicos, 2 salidas con stop.

Miscelatore **termostatico** 3/4" da incasso completo per pannelli doccia con deviatore a **2 uscite** e valvole di non ritorno.

Complete 1/2" concealed thermostatic mixer for shower with ceramic discs diverter, 2 outlets and stop function.

Mitigeur thermostatique 1/2" à encastrer complet pour douche avec inverseur à disques en céramique, 2 sorties et fonction de stop.

Komplett Unterputz 1/2" Thermostat-Mischer, mit Keramik 2-Wegeumsteller mit Stop-Position.

Mezclador termostático 1/2" empotrable completo para ducha con desviador a discos cerámicos, 2 salidas con stop.

Miscelatore **termostatico** 3/4" da incasso completo per pannelli doccia con deviatore a **2 uscite** e valvole di non ritorno.

Complete 1/2" concealed thermostatic mixer for shower with ceramic discs diverter, 2 outlets and stop function.

Mitigeur thermostatique 1/2" à encastrer complet pour douche avec inverseur à disques en céramique, 2 sorties et fonction de stop.

Komplett Unterputz 1/2" Thermostat-Mischer, mit Keramik 2-Wegeumsteller mit Stop-Position.

Mezclador termostático 1/2" empotrable completo para ducha con desviador a discos cerámicos, 2 salidas con stop.

Miscelatore **termostatico** 3/4" da incasso completo per pannelli doccia con deviatore a **2 uscite** e valvole di non ritorno.

Complete 1/2" concealed thermostatic mixer for shower with ceramic discs diverter, 2 outlets and stop function.

Mitigeur thermostatique 1/2" à encastrer complet pour douche avec inverseur à disques en céramique, 2 sorties et fonction de stop.

Komplett Unterputz 1/2" Thermostat-Mischer, mit Keramik 2-Wegeumsteller mit Stop-Position.

Mezclador termostático 1/2" empotrable completo para ducha con desviador a discos cerámicos, 2 salidas con stop.

Miscelatore **termostatico** 3/4" da incasso completo per pannelli doccia con deviatore a **2 uscite** e valvole di non ritorno.

Complete 1/2" concealed thermostatic mixer for shower with ceramic discs diverter, 2 outlets and stop function.

Mitigeur thermostatique 1/2" à encastrer complet pour douche avec inverseur à disques en céramique, 2 sorties et fonction de stop.

Komplett Unterputz 1/2" Thermostat-Mischer, mit Keramik 2-Wegeumsteller mit Stop-Position.

Mezclador termostático 1/2" empotrable completo para ducha con desviador a discos cerámicos, 2 salidas con stop.

l/m	8	12	14,5	19	27	38	47
Kg/cm²	0,1	0,2	0,3	0,5	1	2	3

10 € 335,00 ■ box = 16 pz

l/m	8	12	14,5	19	27	38	47
Kg/cm²	0,1	0,2	0,3	0,5	1	2	3

10 € 395,00 ■ box = 16 pz

l/m	8	12	14,5	19	27	38	47
Kg/cm²	0,1	0,2	0,3	0,5	1	2	3

10 € 395,00 ■ box = 16 pz

l/m	8	12	14,5	19	27	38	47
Kg/cm²	0,1	0,2	0,3	0,5	1	2	3

10 € 395,00 ■ box = 16 pz

l/m	8	12	14,5	19	27	38	47
Kg/cm²	0,1	0,2	0,3	0,5	1	2	3

10 € 435,00 ■ box = 16 pz

l/m	8	12	14,5	19	27	38	47
Kg/cm²	0,1	0,2	0,3	0,5	1	2	3

10 € 308,00 ■ box = 16 pz

l/m	8	12	14,5	19	27	38	47
Kg/cm²	0,1	0,2	0,3	0,5	1	2	3

10 € 395,00 ■ box = 16 pz

l/m	8	12	14,5	19	27	38	47
Kg/cm²	0,1	0,2	0,3	0,5	1	2	3

10 € 405,00 ■ box = 16 pz

962472

digit

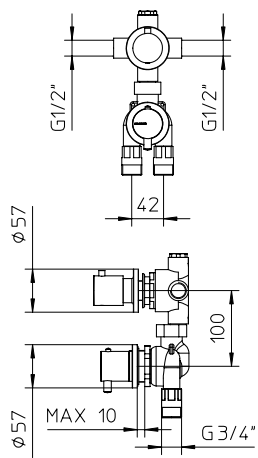

672472

riva

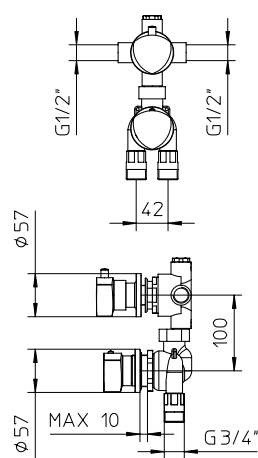

662472

kubik

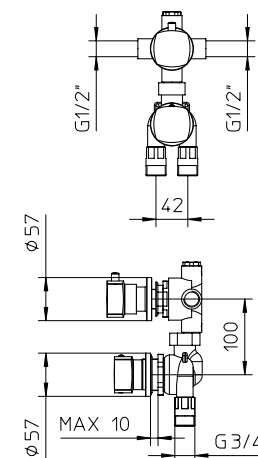

512472

retrò

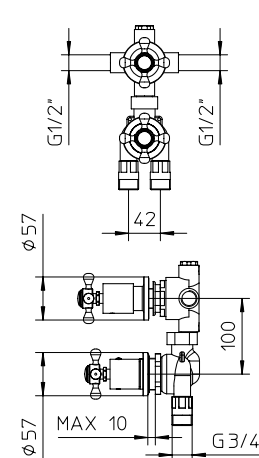

622472

formula

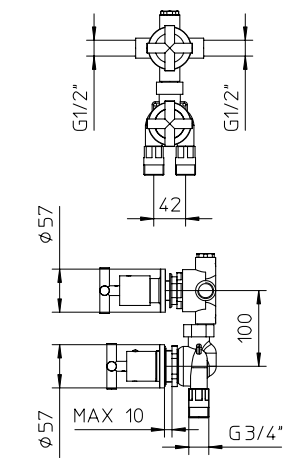

952472

maranello abs

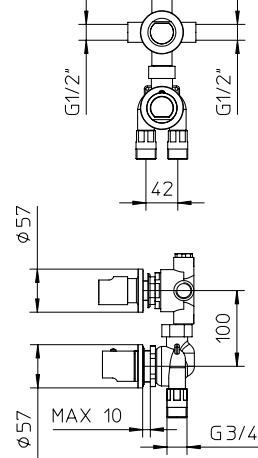

692472

oblique

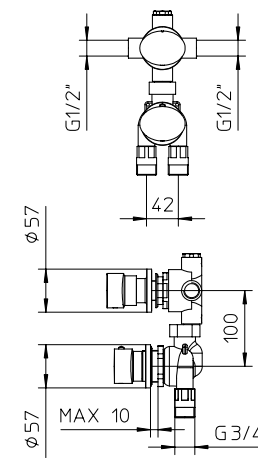

412472

track

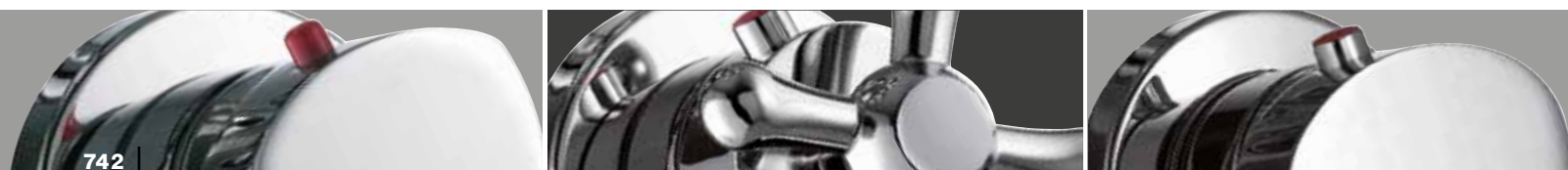
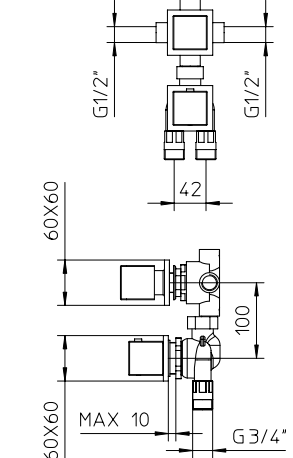

pannelli doccia

Miscelatore **monocomando** 1/2" da incasso completo per pannelli doccia con deviatore a **3 uscite** e valvole di non ritorno.

Complete 1/2" concealed thermostatic mixer for shower with ceramic discs diverter, 3 outlets and stop function.

Mitigeur thermostatique 1/2" à encastrer complet pour douche avec inverseur à disques en céramique, 3 sorties et fonction de stop.

Komplett Unterputz 1/2" Thermostat-Mischer, mit Keramik 3-Wegeumsteller mit Stop-Position.

Mezclador termostático 1/2" empotrable completo para ducha con desviador a discos cerámicos, 3 salidas con stop.

Miscelatore **monocomando** 1/2" da incasso completo per pannelli doccia con deviatore a **3 uscite** e valvole di non ritorno.

Complete 1/2" concealed thermostatic mixer for shower with ceramic discs diverter, 3 outlets and stop function.

Mitigeur thermostatique 1/2" à encastrer complet pour douche avec inverseur à disques en céramique, 3 sorties et fonction de stop.

Komplett Unterputz 1/2" Thermostat-Mischer, mit Keramik 3-Wegeumsteller mit Stop-Position.

Mezclador termostático 1/2" empotrable completo para ducha con desviador a discos cerámicos, 3 salidas con stop.

Miscelatore **monocomando** 1/2" da incasso completo per pannelli doccia con deviatore a **3 uscite** e valvole di non ritorno.

Complete 1/2" concealed thermostatic mixer for shower with ceramic discs diverter, 3 outlets and stop function.

Mitigeur thermostatique 1/2" à encastrer complet pour douche avec inverseur à disques en céramique, 3 sorties et fonction de stop.

Komplett Unterputz 1/2" Thermostat-Mischer, mit Keramik 3-Wegeumsteller mit Stop-Position.

Mezclador termostático 1/2" empotrable completo para ducha con desviador a discos cerámicos, 3 salidas con stop.

Miscelatore **termostatico** 1/2" da incasso completo per pannelli doccia con deviatore a **3 uscite** e valvole di non ritorno.

Complete 1/2" concealed thermostatic mixer for shower with ceramic discs diverter, 3 outlets and stop function.

Mitigeur thermostatique 1/2" à encastrer complet pour douche avec inverseur à disques en céramique, 3 sorties et fonction de stop.

Komplett Unterputz 1/2" Thermostat-Mischer, mit Keramik 3-Wegeumsteller mit Stop-Position.

Mezclador termostático 1/2" empotrable completo para ducha con desviador a discos cerámicos, 3 salidas con stop.

Miscelatore **termostatico** 1/2" da incasso completo per pannelli doccia con deviatore a **3 uscite** e valvole di non ritorno.

Complete 1/2" concealed thermostatic mixer for shower with ceramic discs diverter, 3 outlets and stop function.

Mitigeur thermostatique 1/2" à encastrer complet pour douche avec inverseur à disques en céramique, 3 sorties et fonction de stop.

Komplett Unterputz 1/2" Thermostat-Mischer, mit Keramik 3-Wegeumsteller mit Stop-Position.

Mezclador termostático 1/2" empotrable completo para ducha con desviador a discos cerámicos, 3 salidas con stop.

Miscelatore **termostatico** 1/2" da incasso completo per pannelli doccia con deviatore a **3 uscite** e valvole di non ritorno.

Complete 1/2" concealed thermostatic mixer for shower with ceramic discs diverter, 3 outlets and stop function.

Mitigeur thermostatique 1/2" à encastrer complet pour douche avec inverseur à disques en céramique, 3 sorties et fonction de stop.

Komplett Unterputz 1/2" Thermostat-Mischer, mit Keramik 3-Wegeumsteller mit Stop-Position.

Mezclador termostático 1/2" empotrable completo para ducha con desviador a discos cerámicos, 3 salidas con stop.

Miscelatore **termostatico** 1/2" da incasso completo per pannelli doccia con deviatore a **3 uscite** e valvole di non ritorno.

Complete 1/2" concealed thermostatic mixer for shower with ceramic discs diverter, 3 outlets and stop function.

Mitigeur thermostatique 1/2" à encastrer complet pour douche avec inverseur à disques en céramique, 3 sorties et fonction de stop.

Komplett Unterputz 1/2" Thermostat-Mischer, mit Keramik 3-Wegeumsteller mit Stop-Position.

Mezclador termostático 1/2" empotrable completo para ducha con desviador a discos cerámicos, 3 salidas con stop.

Miscelatore **termostatico** 1/2" da incasso completo per pannelli doccia con deviatore a **3 uscite** e valvole di non ritorno.

Complete 1/2" concealed thermostatic mixer for shower with ceramic discs diverter, 3 outlets and stop function.

Mitigeur thermostatique 1/2" à encastrer complet pour douche avec inverseur à disques en céramique, 3 sorties et fonction de stop.

Komplett Unterputz 1/2" Thermostat-Mischer, mit Keramik 3-Wegeumsteller mit Stop-Position.

Mezclador termostático 1/2" empotrable completo para ducha con desviador a discos cerámicos, 3 salidas con stop.

l/m	8	11	15	18	21
Kg/cm²	0,5	1	2	3	4
10 € 165,00	▪ box = 16 pz				

l/m	8	11	15	18	21
Kg/cm²	0,5	1	2	3	4
10 € 205,00	▪ box = 16 pz				

l/m	8	11	15	18	21
Kg/cm²	0,5	1	2	3	4
10 € 275,00	▪ box = 16 pz				

l/m	8	12	15	17	19
Kg/cm²	1	2	3	4	5
10 € 225,00	▪ box = 16 pz				

l/m	12	17	21	23	27
Kg/cm²	1	2	3	4	5
10 € 275,00	▪ box = 16 pz				

l/m	12	17	21	23	27
Kg/cm²	1	2	3	4	5
10 € 255,00	▪ box = 16 pz				

l/m	12	17	21	23	27
Kg/cm²	1	2	3	4	5
10 € 255,00	▪ box = 16 pz				

l/m	12	17	21	23	27
Kg/cm²	1	2	3	4	5
10 € 345,00	▪ box = 16 pz				

402458

proxima

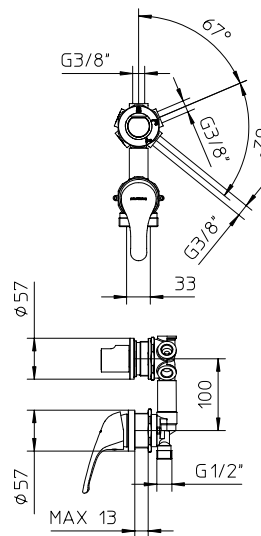

122458

idrotech

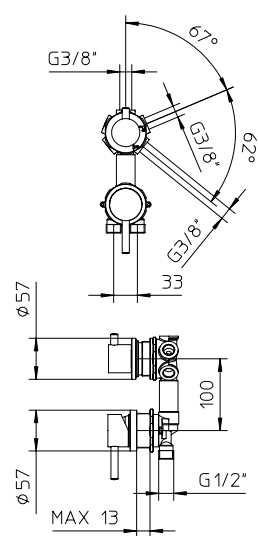

092458

track

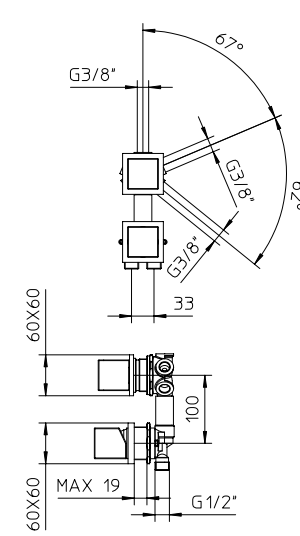

110103

digit abs

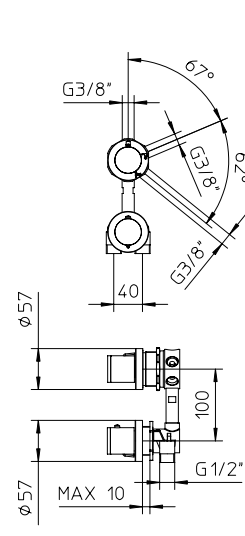

962438

digit

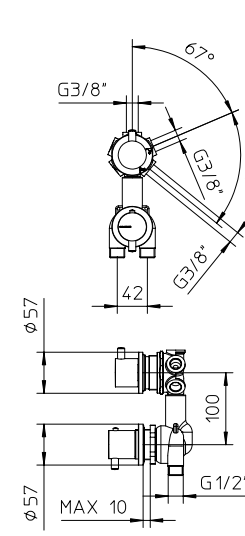

112438

digit abs

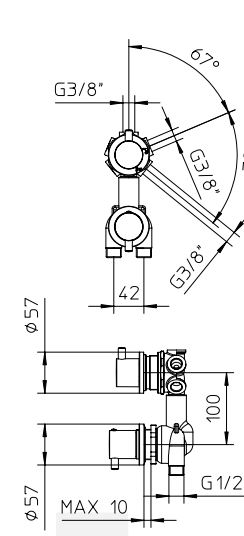

952438

maranello abs

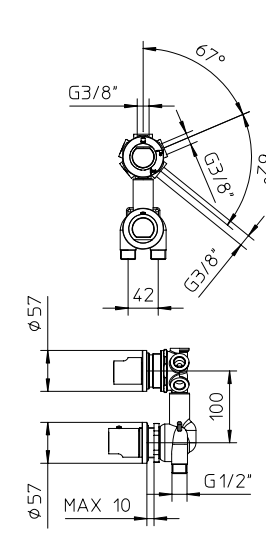

412438

track

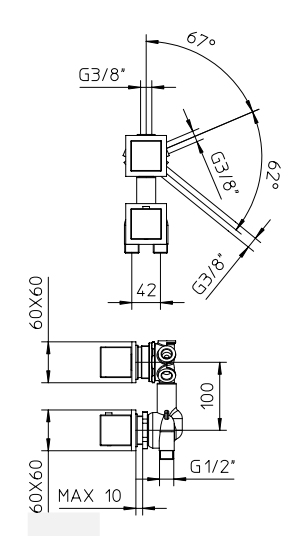

pannelli doccia

Miscelatore **termostatico** 3/4" da incasso completo per pannelli doccia con deviatore a **3 uscite** e valvole di non ritorno.

Complete 1/2" concealed thermostatic mixer for shower with ceramic discs diverter, 3 outlets and stop function.

Mitigeur thermostatique 1/2" à encastrer complet pour douche avec inverseur à disques en céramique, 3 sorties et fonction de stop.

Komplett Unterputz 1/2" Thermostat-Mischer, mit Keramik 3-Wegeumsteller mit Stop-Position.

Mezclador termostático 1/2" empotrable completo para ducha con desviador a discos cerámicos, 3 salidas con stop.

Miscelatore **termostatico** 3/4" da incasso completo per pannelli doccia con deviatore a **3 uscite** e valvole di non ritorno.

Complete 1/2" concealed thermostatic mixer for shower with ceramic discs diverter, 3 outlets and stop function.

Mitigeur thermostatique 1/2" à encastrer complet pour douche avec inverseur à disques en céramique, 3 sorties et fonction de stop.

Komplett Unterputz 1/2" Thermostat-Mischer, mit Keramik 3-Wegeumsteller mit Stop-Position.

Mezclador termostático 1/2" empotrable completo para ducha con desviador a discos cerámicos, 3 salidas con stop.

Miscelatore **termostatico** 3/4" da incasso completo per pannelli doccia con deviatore a **3 uscite** e valvole di non ritorno.

Complete 1/2" concealed thermostatic mixer for shower with ceramic discs diverter, 3 outlets and stop function.

Mitigeur thermostatique 1/2" à encastrer complet pour douche avec inverseur à disques en céramique, 3 sorties et fonction de stop.

Komplett Unterputz 1/2" Thermostat-Mischer, mit Keramik 3-Wegeumsteller mit Stop-Position.

Mezclador termostático 1/2" empotrable completo para ducha con desviador a discos cerámicos, 3 salidas con stop.

Miscelatore **termostatico** 3/4" da incasso completo per pannelli doccia con deviatore a **3 uscite** e valvole di non ritorno.

Complete 1/2" concealed thermostatic mixer for shower with ceramic discs diverter, 3 outlets and stop function.

Mitigeur thermostatique 1/2" à encastrer complet pour douche avec inverseur à disques en céramique, 3 sorties et fonction de stop.

Komplett Unterputz 1/2" Thermostat-Mischer, mit Keramik 3-Wegeumsteller mit Stop-Position.

Mezclador termostático 1/2" empotrable completo para ducha con desviador a discos cerámicos, 3 salidas con stop.

Miscelatore **termostatico** 3/4" da incasso completo per pannelli doccia con deviatore a **3 uscite** e valvole di non ritorno.

Complete 1/2" concealed thermostatic mixer for shower with ceramic discs diverter, 3 outlets and stop function.

Mitigeur thermostatique 1/2" à encastrer complet pour douche avec inverseur à disques en céramique, 3 sorties et fonction de stop.

Komplett Unterputz 1/2" Thermostat-Mischer, mit Keramik 3-Wegeumsteller mit Stop-Position.

Mezclador termostático 1/2" empotrable completo para ducha con desviador a discos cerámicos, 3 salidas con stop.

Miscelatore **termostatico** 3/4" da incasso completo per pannelli doccia con deviatore a **3 uscite** e valvole di non ritorno.

Complete 1/2" concealed thermostatic mixer for shower with ceramic discs diverter, 3 outlets and stop function.

Mitigeur thermostatique 1/2" à encastrer complet pour douche avec inverseur à disques en céramique, 3 sorties et fonction de stop.

Komplett Unterputz 1/2" Thermostat-Mischer, mit Keramik 3-Wegeumsteller mit Stop-Position.

Mezclador termostático 1/2" empotrable completo para ducha con desviador a discos cerámicos, 3 salidas con stop.

Miscelatore **termostatico** 3/4" da incasso completo per pannelli doccia con deviatore a **3 uscite** e valvole di non ritorno.

Complete 1/2" concealed thermostatic mixer for shower with ceramic discs diverter, 3 outlets and stop function.

Mitigeur thermostatique 1/2" à encastrer complet pour douche avec inverseur à disques en céramique, 3 sorties et fonction de stop.

Komplett Unterputz 1/2" Thermostat-Mischer, mit Keramik 3-Wegeumsteller mit Stop-Position.

Mezclador termostático 1/2" empotrable completo para ducha con desviador a discos cerámicos, 3 salidas con stop.

Miscelatore **termostatico** 3/4" da incasso completo per pannelli doccia con deviatore a **3 uscite** e valvole di non ritorno.

Complete 1/2" concealed thermostatic mixer for shower with ceramic discs diverter, 3 outlets and stop function.

Mitigeur thermostatique 1/2" à encastrer complet pour douche avec inverseur à disques en céramique, 3 sorties et fonction de stop.

Komplett Unterputz 1/2" Thermostat-Mischer, mit Keramik 3-Wegeumsteller mit Stop-Position.

Mezclador termostático 1/2" empotrable completo para ducha con desviador a discos cerámicos, 3 salidas con stop.

l/m	8	12	14,5	19	27	38	47
Kg/cm²	0,1	0,2	0,3	0,5	1	2	3

10 € 345,00 ■ box = 16 pz

l/m	8	12	14,5	19	27	38	47
Kg/cm²	0,1	0,2	0,3	0,5	1	2	3

10 € 405,00 ■ box = 16 pz

l/m	8	12	14,5	19	27	38	47
Kg/cm²	0,1	0,2	0,3	0,5	1	2	3

10 € 405,00 ■ box = 16 pz

l/m	8	12	14,5	19	27	38	47
Kg/cm²	0,1	0,2	0,3	0,5	1	2	3

10 € 405,00 ■ box = 16 pz

l/m	8	12	14,5	19	27	38	47
Kg/cm²	0,1	0,2	0,3	0,5	1	2	3

10 € 445,00 ■ box = 16 pz

l/m	8	12	14,5	19	27	38	47
Kg/cm²	0,1	0,2	0,3	0,5	1	2	3

10 € 318,00 ■ box = 16 pz

l/m	8	12	14,5	19	27	38	47
Kg/cm²	0,1	0,2	0,3	0,5	1	2	3

10 € 405,00 ■ box = 16 pz

l/m	8	12	14,5	19	27	38	47
Kg/cm²	0,1	0,2	0,3	0,5	1	2	3

10 € 415,00 ■ box = 16 pz

962473

digit

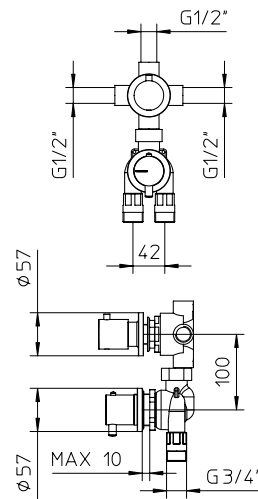

672473

riva

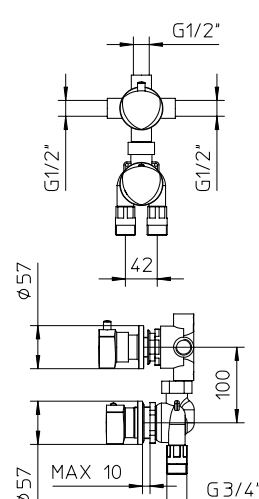

662473

kubik

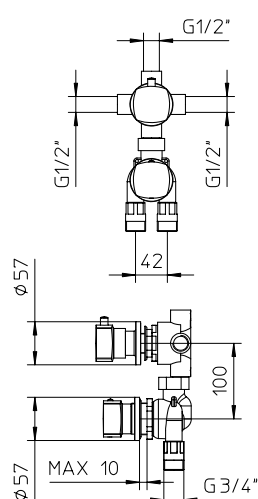

512473

retrò

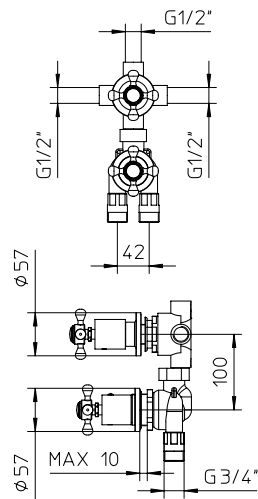

622473

formula

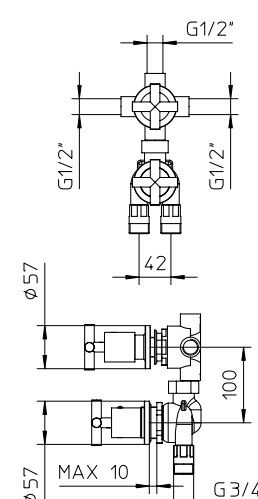

952473

maranello abs

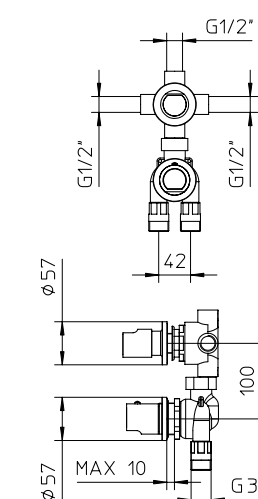

692473

oblique

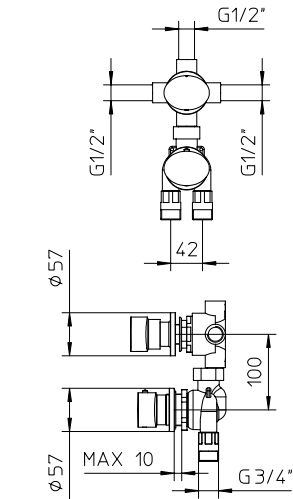

412473

track

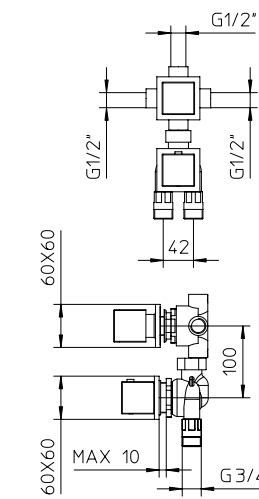

Miscelatore **monocomando** 1/2" da incasso completo per pannelli doccia con deviatore a **4 uscite** e valvole di non ritorno.

Complete 1/2" concealed thermostatic mixer for shower with ceramic discs diverter, 4 outlets and stop function.

Mitigeur thermostatique 1/2" à encastrer complet pour douche avec inverseur à disques en céramique, 4 sorties et fonction de stop.

Komplett Unterputz 1/2" Thermostat-Mischer, mit Keramik 4-Wegeumsteller mit Stop-Position.

Mezclador termostático 1/2" empotrable completo para ducha con desviador a discos cerámicos, 4 salidas con stop.

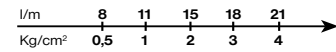

10 € 165,00 ■ box = 16 pz

Miscelatore **monocomando** 1/2" da incasso completo per pannelli doccia con deviatore a **4 uscite** e valvole di non ritorno.

Complete 1/2" concealed thermostatic mixer for shower with ceramic discs diverter, 4 outlets and stop function.

Mitigeur thermostatique 1/2" à encastrer complet pour douche avec inverseur à disques en céramique, 4 sorties et fonction de stop.

Komplett Unterputz 1/2" Thermostat-Mischer, mit Keramik 4-Wegeumsteller mit Stop-Position.

Mezclador termostático 1/2" empotrable completo para ducha con desviador a discos cerámicos, 4 salidas con stop.

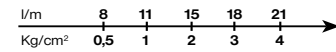

10 € 205,00 ■ box = 16 pz

Miscelatore **monocomando** 1/2" da incasso completo per pannelli doccia con deviatore a **4 uscite** e valvole di non ritorno.

Complete 1/2" concealed thermostatic mixer for shower with ceramic discs diverter, 4 outlets and stop function.

Mitigeur thermostatique 1/2" à encastrer complet pour douche avec inverseur à disques en céramique, 4 sorties et fonction de stop.

Komplett Unterputz 1/2" Thermostat-Mischer, mit Keramik 4-Wegeumsteller mit Stop-Position.

Mezclador termostático 1/2" empotrable completo para ducha con desviador a discos cerámicos, 4 salidas con stop.

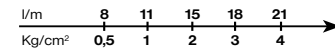

10 € 275,00 ■ box = 16 pz

Miscelatore **termostatico** 1/2" da incasso completo per pannelli doccia con deviatore a **4 uscite** e valvole di non ritorno.

Complete 1/2" concealed thermostatic mixer for shower with ceramic discs diverter, 4 outlets and stop function.

Mitigeur thermostatique 1/2" à encastrer complet pour douche avec inverseur à disques en céramique, 4 sorties et fonction de stop.

Komplett Unterputz 1/2" Thermostat-Mischer, mit Keramik 4-Wegeumsteller mit Stop-Position.

Mezclador termostático 1/2" empotrable completo para ducha con desviador a discos cerámicos, 4 salidas con stop.

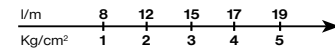

10 € 225,00 ■ box = 16 pz

Miscelatore **termostatico** 1/2" da incasso completo per pannelli doccia con deviatore a **4 uscite** e valvole di non ritorno.

Complete 1/2" concealed thermostatic mixer for shower with ceramic discs diverter, 4 outlets and stop function.

Mitigeur thermostatique 1/2" à encastrer complet pour douche avec inverseur à disques en céramique, 4 sorties et fonction de stop.

Komplett Unterputz 1/2" Thermostat-Mischer, mit Keramik 4-Wegeumsteller mit Stop-Position.

Mezclador termostático 1/2" empotrable completo para ducha con desviador a discos cerámicos, 4 salidas con stop.

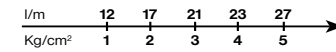

10 € 275,00 ■ box = 16 pz

Miscelatore **termostatico** 1/2" da incasso completo per pannelli doccia con deviatore a **4 uscite** e valvole di non ritorno.

Complete 1/2" concealed thermostatic mixer for shower with ceramic discs diverter, 4 outlets and stop function.

Mitigeur thermostatique 1/2" à encastrer complet pour douche avec inverseur à disques en céramique, 4 sorties et fonction de stop.

Komplett Unterputz 1/2" Thermostat-Mischer, mit Keramik 4-Wegeumsteller mit Stop-Position.

Mezclador termostático 1/2" empotrable completo para ducha con desviador a discos cerámicos, 4 salidas con stop.

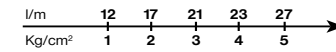

10 € 255,00 ■ box = 16 pz

Miscelatore **termostatico** 1/2" da incasso completo per pannelli doccia con deviatore a **4 uscite** e valvole di non ritorno.

Complete 1/2" concealed thermostatic mixer for shower with ceramic discs diverter, 4 outlets and stop function.

Mitigeur thermostatique 1/2" à encastrer complet pour douche avec inverseur à disques en céramique, 4 sorties et fonction de stop.

Komplett Unterputz 1/2" Thermostat-Mischer, mit Keramik 4-Wegeumsteller mit Stop-Position.

Mezclador termostático 1/2" empotrable completo para ducha con desviador a discos cerámicos, 4 salidas con stop.

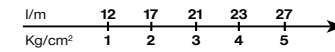

10 € 255,00 ■ box = 16 pz

Miscelatore **termostatico** 1/2" da incasso completo per pannelli doccia con deviatore a **4 uscite** e valvole di non ritorno.

Complete 1/2" concealed thermostatic mixer for shower with ceramic discs diverter, 4 outlets and stop function.

Mitigeur thermostatique 1/2" à encastrer complet pour douche avec inverseur à disques en céramique, 4 sorties et fonction de stop.

Komplett Unterputz 1/2" Thermostat-Mischer, mit Keramik 4-Wegeumsteller mit Stop-Position.

Mezclador termostático 1/2" empotrable completo para ducha con desviador a discos cerámicos, 4 salidas con stop.

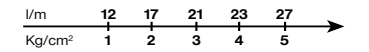

10 € 345,00 ■ box = 16 pz

402457

proxima

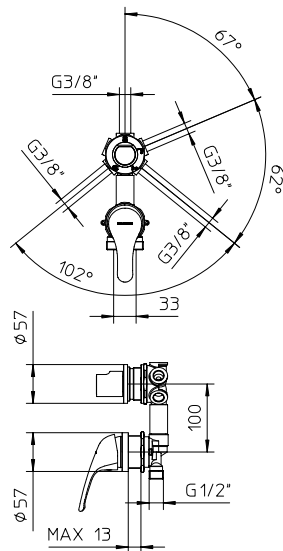

122457

idrotech

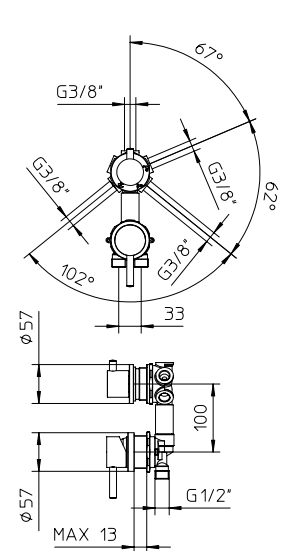

092457

track

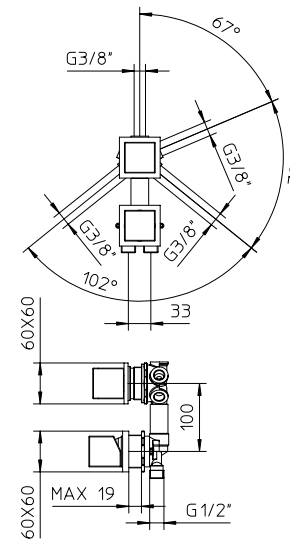

110104

digit abs

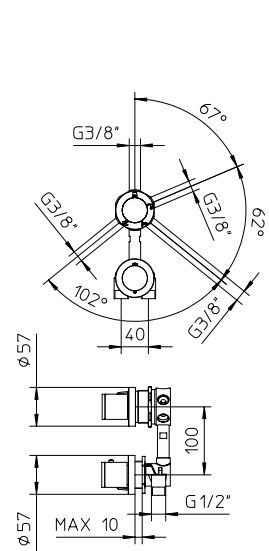

962437

digit

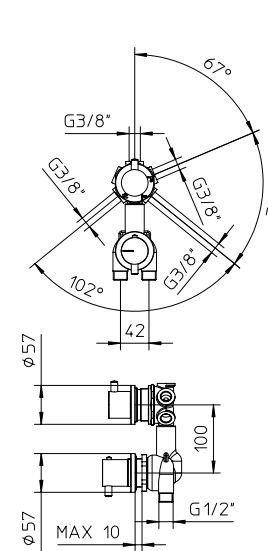

112437

digit abs

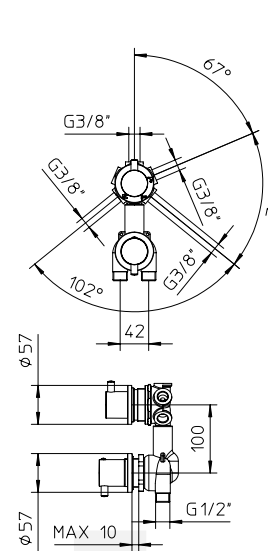

952437

maranello abs

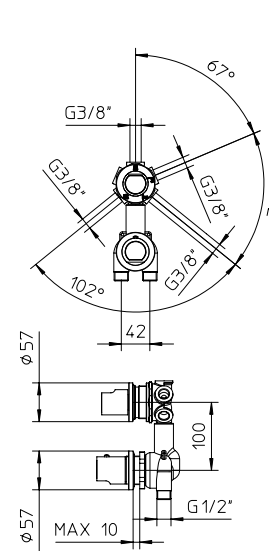

412437

track

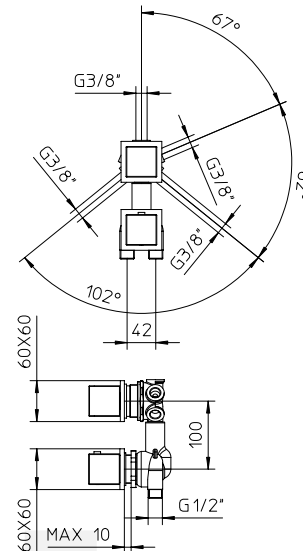

Miscelatore **termostatico** 3/4" da incasso completo per pannelli doccia con deviatore a **4 uscite** e valvole di non ritorno.

Complete 1/2" concealed thermostatic mixer for shower with ceramic discs diverter, 4 outlets and stop function.

Mitigeur thermostatique 1/2" à encastrer complet pour douche avec inverseur à disques en céramique, 4 sorties et fonction de stop.

Komplett Unterputz 1/2" Thermostat-Mischer, mit Keramik 4-Wegeumsteller mit Stop-Position.

Mezclador termostático 1/2" empotrable completo para ducha con desviador a discos cerámicos, 4 salidas con stop.

Miscelatore **termostatico** 3/4" da incasso completo per pannelli doccia con deviatore a **4 uscite** e valvole di non ritorno.

Complete 1/2" concealed thermostatic mixer for shower with ceramic discs diverter, 4 outlets and stop function.

Mitigeur thermostatique 1/2" à encastrer complet pour douche avec inverseur à disques en céramique, 4 sorties et fonction de stop.

Komplett Unterputz 1/2" Thermostat-Mischer, mit Keramik 4-Wegeumsteller mit Stop-Position.

Mezclador termostático 1/2" empotrable completo para ducha con desviador a discos cerámicos, 4 salidas con stop.

Miscelatore **termostatico** 3/4" da incasso completo per pannelli doccia con deviatore a **4 uscite** e valvole di non ritorno.

Complete 1/2" concealed thermostatic mixer for shower with ceramic discs diverter, 4 outlets and stop function.

Mitigeur thermostatique 1/2" à encastrer complet pour douche avec inverseur à disques en céramique, 4 sorties et fonction de stop.

Komplett Unterputz 1/2" Thermostat-Mischer, mit Keramik 4-Wegeumsteller mit Stop-Position.

Mezclador termostático 1/2" empotrable completo para ducha con desviador a discos cerámicos, 4 salidas con stop.

Miscelatore **termostatico** 3/4" da incasso completo per pannelli doccia con deviatore a **4 uscite** e valvole di non ritorno.

Complete 1/2" concealed thermostatic mixer for shower with ceramic discs diverter, 4 outlets and stop function.

Mitigeur thermostatique 1/2" à encastrer complet pour douche avec inverseur à disques en céramique, 4 sorties et fonction de stop.

Komplett Unterputz 1/2" Thermostat-Mischer, mit Keramik 4-Wegeumsteller mit Stop-Position.

Mezclador termostático 1/2" empotrable completo para ducha con desviador a discos cerámicos, 4 salidas con stop.

Miscelatore **termostatico** 3/4" da incasso completo per pannelli doccia con deviatore a **4 uscite** e valvole di non ritorno.

Complete 1/2" concealed thermostatic mixer for shower with ceramic discs diverter, 4 outlets and stop function.

Mitigeur thermostatique 1/2" à encastrer complet pour douche avec inverseur à disques en céramique, 4 sorties et fonction de stop.

Komplett Unterputz 1/2" Thermostat-Mischer, mit Keramik 4-Wegeumsteller mit Stop-Position.

Mezclador termostático 1/2" empotrable completo para ducha con desviador a discos cerámicos, 4 salidas con stop.

Miscelatore **termostatico** 3/4" da incasso completo per pannelli doccia con deviatore a **4 uscite** e valvole di non ritorno.

Complete 1/2" concealed thermostatic mixer for shower with ceramic discs diverter, 4 outlets and stop function.

Mitigeur thermostatique 1/2" à encastrer complet pour douche avec inverseur à disques en céramique, 4 sorties et fonction de stop.

Komplett Unterputz 1/2" Thermostat-Mischer, mit Keramik 4-Wegeumsteller mit Stop-Position.

Mezclador termostático 1/2" empotrable completo para ducha con desviador a discos cerámicos, 4 salidas con stop.

Miscelatore **termostatico** 3/4" da incasso completo per pannelli doccia con deviatore a **4 uscite** e valvole di non ritorno.

Complete 1/2" concealed thermostatic mixer for shower with ceramic discs diverter, 4 outlets and stop function.

Mitigeur thermostatique 1/2" à encastrer complet pour douche avec inverseur à disques en céramique, 4 sorties et fonction de stop.

Komplett Unterputz 1/2" Thermostat-Mischer, mit Keramik 4-Wegeumsteller mit Stop-Position.

Mezclador termostático 1/2" empotrable completo para ducha con desviador a discos cerámicos, 4 salidas con stop.

Miscelatore **termostatico** 3/4" da incasso completo per pannelli doccia con deviatore a **4 uscite** e valvole di non ritorno.

Complete 1/2" concealed thermostatic mixer for shower with ceramic discs diverter, 4 outlets and stop function.

Mitigeur thermostatique 1/2" à encastrer complet pour douche avec inverseur à disques en céramique, 4 sorties et fonction de stop.

Komplett Unterputz 1/2" Thermostat-Mischer, mit Keramik 4-Wegeumsteller mit Stop-Position.

Mezclador termostático 1/2" empotrable completo para ducha con desviador a discos cerámicos, 4 salidas con stop.

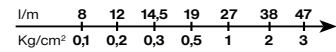

10 € 355,00 ■ box = 16 pz

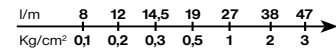

10 € 415,00 ■ box = 16 pz

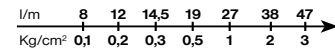

10 € 415,00 ■ box = 16 pz

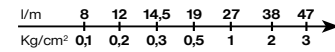

10 € 415,00 ■ box = 16 pz

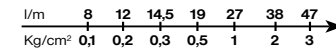

10 € 455,00 ■ box = 16 pz

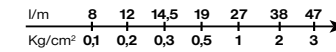

10 € 328,00 ■ box = 16 pz

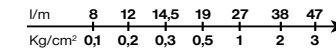

10 € 415,00 ■ box = 16 pz

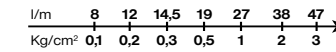

10 € 425,00 ■ box = 16 pz

962474

digit

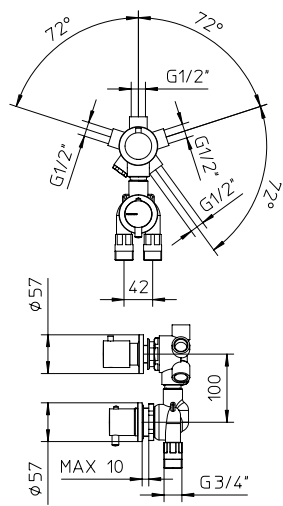

672474

riva

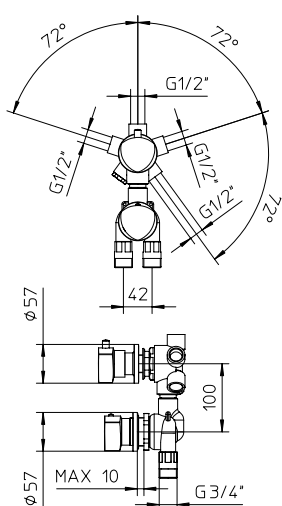

662474

kubik

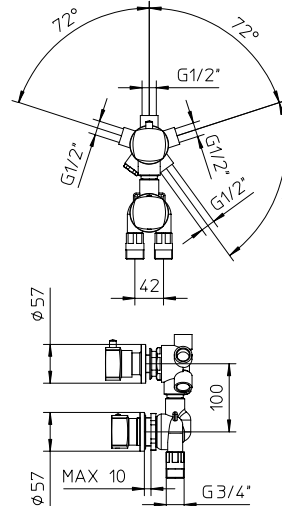

512474

retrò

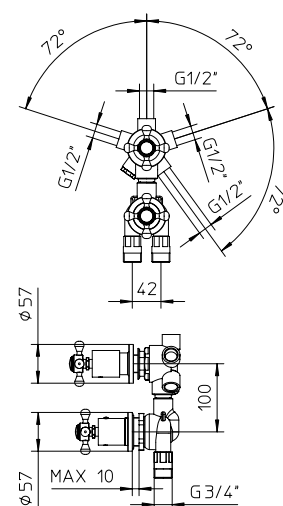

622474

formula

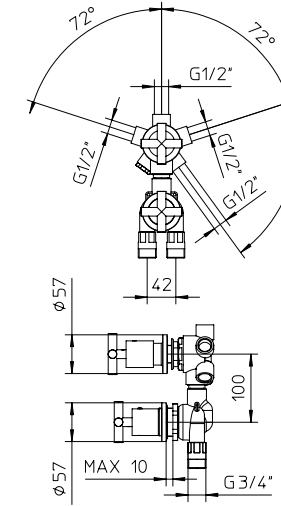

952474

maranello abs

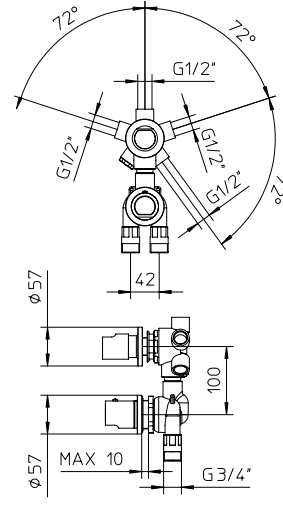

692474

oblique

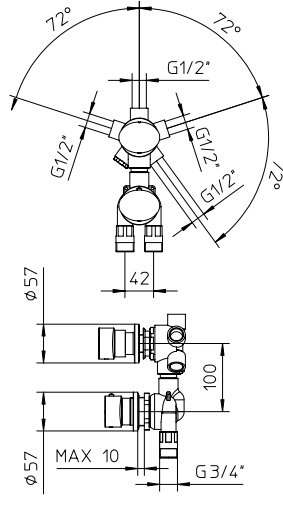

412474

track

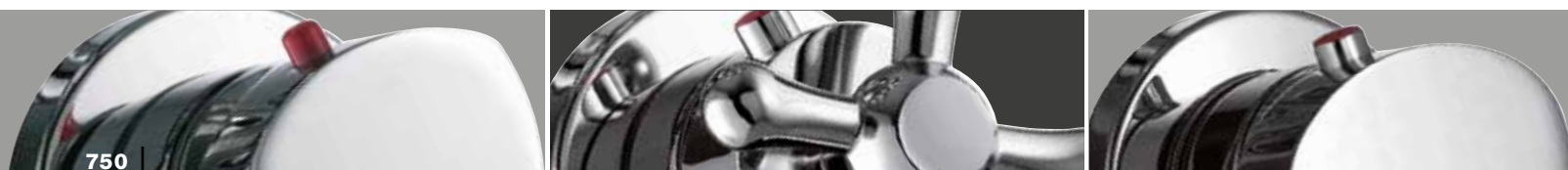
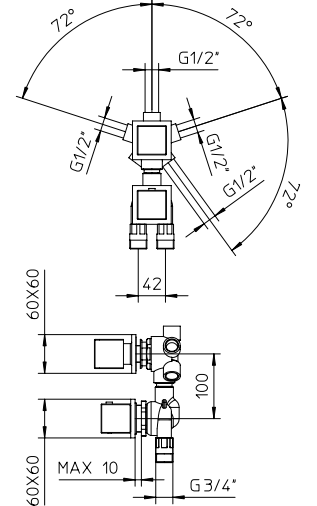

pannelli doccia

Miscelatore **monocomando** 1/2" da incasso completo per pannelli doccia con deviatore a **5 uscite** e valvole di non ritorno.

Complete 1/2" concealed thermostatic mixer for shower with ceramic discs diverter, 5 outlets and stop function.

Mitigeur thermostatique 1/2" à encastrer complet pour douche avec inverseur à disques en céramique, 5 sorties et fonction de stop.

Komplett Unterputz 1/2" Thermostat-Mischer, mit Keramik 5-Wegeumsteller mit Stop-Position.

Mezclador termostático 1/2" empotrable completo para ducha con desviador a discos cerámicos, 5 salidas con stop.

Miscelatore **monocomando** 1/2" da incasso completo per pannelli doccia con deviatore a **5 uscite** e valvole di non ritorno.

Complete 1/2" concealed thermostatic mixer for shower with ceramic discs diverter, 5 outlets and stop function.

Mitigeur thermostatique 1/2" à encastrer complet pour douche avec inverseur à disques en céramique, 5 sorties et fonction de stop.

Komplett Unterputz 1/2" Thermostat-Mischer, mit Keramik 5-Wegeumsteller mit Stop-Position.

Mezclador termostático 1/2" empotrable completo para ducha con desviador a discos cerámicos, 5 salidas con stop.

Miscelatore **monocomando** 1/2" da incasso completo per pannelli doccia con deviatore a **5 uscite** e valvole di non ritorno.

Complete 1/2" concealed thermostatic mixer for shower with ceramic discs diverter, 5 outlets and stop function.

Mitigeur thermostatique 1/2" à encastrer complet pour douche avec inverseur à disques en céramique, 5 sorties et fonction de stop.

Komplett Unterputz 1/2" Thermostat-Mischer, mit Keramik 5-Wegeumsteller mit Stop-Position.

Mezclador termostático 1/2" empotrable completo para ducha con desviador a discos cerámicos, 5 salidas con stop.

Miscelatore **termostatico** 1/2" da incasso completo per pannelli doccia con deviatore a **5 uscite** e valvole di non ritorno.

Complete 1/2" concealed thermostatic mixer for shower with ceramic discs diverter, 5 outlets and stop function.

Mitigeur thermostatique 1/2" à encastrer complet pour douche avec inverseur à disques en céramique, 5 sorties et fonction de stop.

Komplett Unterputz 1/2" Thermostat-Mischer, mit Keramik 5-Wegeumsteller mit Stop-Position.

Mezclador termostático 1/2" empotrable completo para ducha con desviador a discos cerámicos, 5 salidas con stop.

Miscelatore **termostatico** 1/2" da incasso completo per pannelli doccia con deviatore a **5 uscite** e valvole di non ritorno.

Complete 1/2" concealed thermostatic mixer for shower with ceramic discs diverter, 5 outlets and stop function.

Mitigeur thermostatique 1/2" à encastrer complet pour douche avec inverseur à disques en céramique, 5 sorties et fonction de stop.

Komplett Unterputz 1/2" Thermostat-Mischer, mit Keramik 5-Wegeumsteller mit Stop-Position.

Mezclador termostático 1/2" empotrable completo para ducha con desviador a discos cerámicos, 5 salidas con stop.

Miscelatore **termostatico** 1/2" da incasso completo per pannelli doccia con deviatore a **5 uscite** e valvole di non ritorno.

Complete 1/2" concealed thermostatic mixer for shower with ceramic discs diverter, 5 outlets and stop function.

Mitigeur thermostatique 1/2" à encastrer complet pour douche avec inverseur à disques en céramique, 5 sorties et fonction de stop.

Komplett Unterputz 1/2" Thermostat-Mischer, mit Keramik 5-Wegeumsteller mit Stop-Position.

Mezclador termostático 1/2" empotrable completo para ducha con desviador a discos cerámicos, 5 salidas con stop.

Miscelatore **termostatico** 1/2" da incasso completo per pannelli doccia con deviatore a **5 uscite** e valvole di non ritorno.

Complete 1/2" concealed thermostatic mixer for shower with ceramic discs diverter, 5 outlets and stop function.

Mitigeur thermostatique 1/2" à encastrer complet pour douche avec inverseur à disques en céramique, 5 sorties et fonction de stop.

Komplett Unterputz 1/2" Thermostat-Mischer, mit Keramik 5-Wegeumsteller mit Stop-Position.

Mezclador termostático 1/2" empotrable completo para ducha con desviador a discos cerámicos, 5 salidas con stop.

Miscelatore **termostatico** 1/2" da incasso completo per pannelli doccia con deviatore a **5 uscite** e valvole di non ritorno.

Complete 1/2" concealed thermostatic mixer for shower with ceramic discs diverter, 5 outlets and stop function.

Mitigeur thermostatique 1/2" à encastrer complet pour douche avec inverseur à disques en céramique, 5 sorties et fonction de stop.

Komplett Unterputz 1/2" Thermostat-Mischer, mit Keramik 5-Wegeumsteller mit Stop-Position.

Mezclador termostático 1/2" empotrable completo para ducha con desviador a discos cerámicos, 5 salidas con stop.

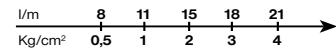

10 € 165,00 ■ box = 16 pz

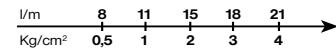

10 € 205,00 ■ box = 16 pz

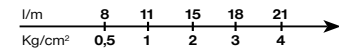

10 € 275,00 ■ box = 16 pz

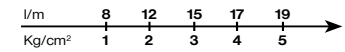

10 € 225,00 ■ box = 16 pz

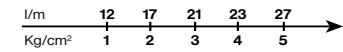

10 € 275,00 ■ box = 16 pz

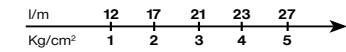

10 € 255,00 ■ box = 16 pz

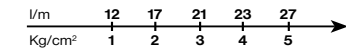

10 € 255,00 ■ box = 16 pz

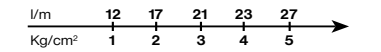

10 € 345,00 ■ box = 16 pz

402456

proxima

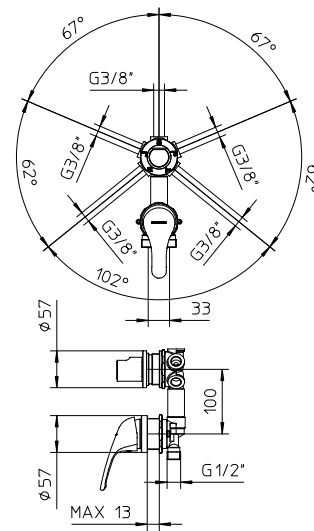

122456

idrotech

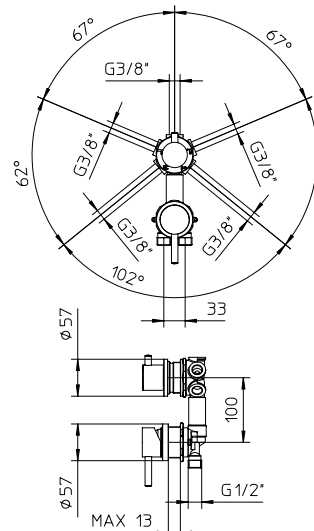

092456

track

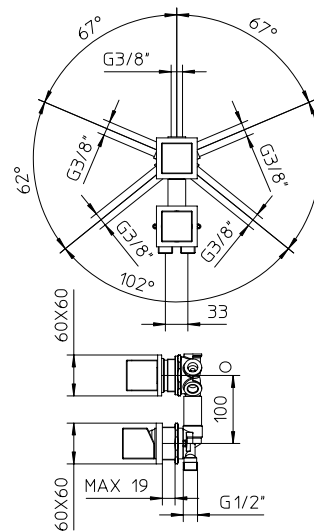

110105

digit abs

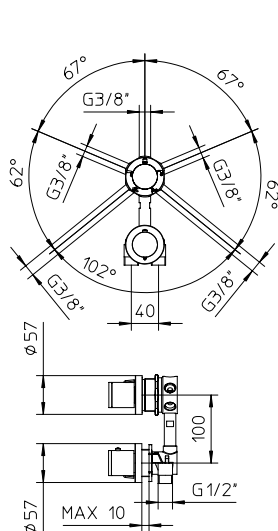

962436

digit

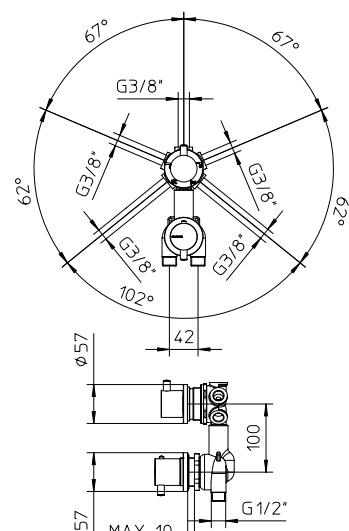

112436

digit abs

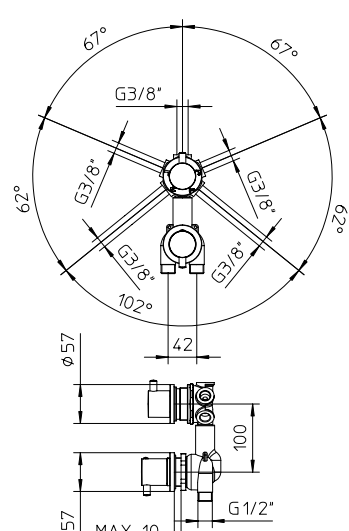

952436

maranello abs

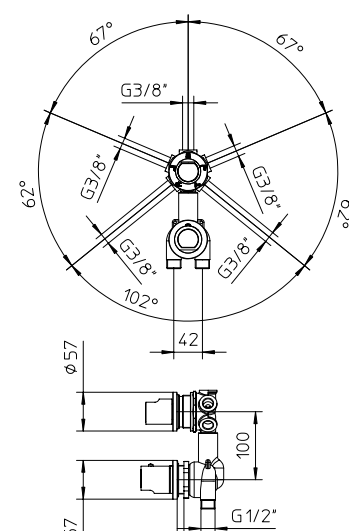

412436

track

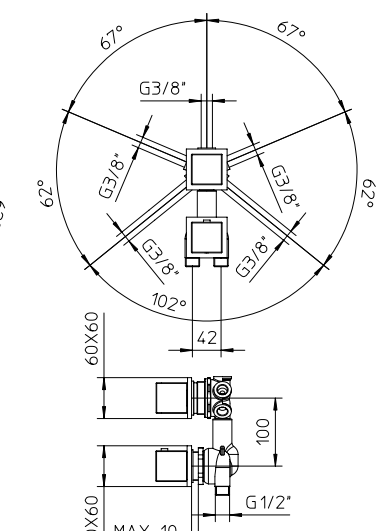

Miscelatore **termostatico** 3/4" da incasso completo per pannelli doccia con deviatore a **5 uscite** e valvole di non ritorno.

Complete 1/2" concealed thermostatic mixer for shower with ceramic discs diverter, 5 outlets and stop function.

Mitigeur thermostatique 1/2" à encastrer complet pour douche avec inverseur à disques en céramique, 5 sorties et fonction de stop.

Komplett Unterputz 1/2" Thermostat-Mischer, mit Keramik 5-Wegeumsteller mit Stop-Position.

Mezclador termostático 1/2" empotrable completo para ducha con desviador a discos cerámicos, 5 salidas con stop.

Miscelatore **termostatico** 3/4" da incasso completo per pannelli doccia con deviatore a **5 uscite** e valvole di non ritorno.

Complete 1/2" concealed thermostatic mixer for shower with ceramic discs diverter, 5 outlets and stop function.

Mitigeur thermostatique 1/2" à encastrer complet pour douche avec inverseur à disques en céramique, 5 sorties et fonction de stop.

Komplett Unterputz 1/2" Thermostat-Mischer, mit Keramik 5-Wegeumsteller mit Stop-Position.

Mezclador termostático 1/2" empotrable completo para ducha con desviador a discos cerámicos, 5 salidas con stop.

Miscelatore **termostatico** 3/4" da incasso completo per pannelli doccia con deviatore a **5 uscite** e valvole di non ritorno.

Complete 1/2" concealed thermostatic mixer for shower with ceramic discs diverter, 5 outlets and stop function.

Mitigeur thermostatique 1/2" à encastrer complet pour douche avec inverseur à disques en céramique, 5 sorties et fonction de stop.

Komplett Unterputz 1/2" Thermostat-Mischer, mit Keramik 5-Wegeumsteller mit Stop-Position.

Mezclador termostático 1/2" empotrable completo para ducha con desviador a discos cerámicos, 5 salidas con stop.

Miscelatore **termostatico** 3/4" da incasso completo per pannelli doccia con deviatore a **5 uscite** e valvole di non ritorno.

Complete 1/2" concealed thermostatic mixer for shower with ceramic discs diverter, 5 outlets and stop function.

Mitigeur thermostatique 1/2" à encastrer complet pour douche avec inverseur à disques en céramique, 5 sorties et fonction de stop.

Komplett Unterputz 1/2" Thermostat-Mischer, mit Keramik 5-Wegeumsteller mit Stop-Position.

Mezclador termostático 1/2" empotrable completo para ducha con desviador a discos cerámicos, 5 salidas con stop.

Miscelatore **termostatico** 3/4" da incasso completo per pannelli doccia con deviatore a **5 uscite** e valvole di non ritorno.

Complete 1/2" concealed thermostatic mixer for shower with ceramic discs diverter, 5 outlets and stop function.

Mitigeur thermostatique 1/2" à encastrer complet pour douche avec inverseur à disques en céramique, 5 sorties et fonction de stop.

Komplett Unterputz 1/2" Thermostat-Mischer, mit Keramik 5-Wegeumsteller mit Stop-Position.

Mezclador termostático 1/2" empotrable completo para ducha con desviador a discos cerámicos, 5 salidas con stop.

Miscelatore **termostatico** 3/4" da incasso completo per pannelli doccia con deviatore a **5 uscite** e valvole di non ritorno.

Complete 1/2" concealed thermostatic mixer for shower with ceramic discs diverter, 5 outlets and stop function.

Mitigeur thermostatique 1/2" à encastrer complet pour douche avec inverseur à disques en céramique, 5 sorties et fonction de stop.

Komplett Unterputz 1/2" Thermostat-Mischer, mit Keramik 5-Wegeumsteller mit Stop-Position.

Mezclador termostático 1/2" empotrable completo para ducha con desviador a discos cerámicos, 5 salidas con stop.

Miscelatore **termostatico** 3/4" da incasso completo per pannelli doccia con deviatore a **5 uscite** e valvole di non ritorno.

Complete 1/2" concealed thermostatic mixer for shower with ceramic discs diverter, 5 outlets and stop function.

Mitigeur thermostatique 1/2" à encastrer complet pour douche avec inverseur à disques en céramique, 5 sorties et fonction de stop.

Komplett Unterputz 1/2" Thermostat-Mischer, mit Keramik 5-Wegeumsteller mit Stop-Position.

Mezclador termostático 1/2" empotrable completo para ducha con desviador a discos cerámicos, 5 salidas con stop.

Miscelatore **termostatico** 3/4" da incasso completo per pannelli doccia con deviatore a **5 uscite** e valvole di non ritorno.

Complete 1/2" concealed thermostatic mixer for shower with ceramic discs diverter, 5 outlets and stop function.

Mitigeur thermostatique 1/2" à encastrer complet pour douche avec inverseur à disques en céramique, 5 sorties et fonction de stop.

Komplett Unterputz 1/2" Thermostat-Mischer, mit Keramik 5-Wegeumsteller mit Stop-Position.

Mezclador termostático 1/2" empotrable completo para ducha con desviador a discos cerámicos, 5 salidas con stop.

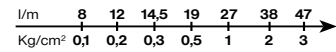

10 € 355,00 ■ box = 16 pz

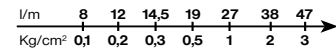

10 € 415,00 ■ box = 16 pz

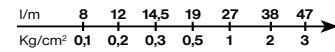

10 € 415,00 ■ box = 16 pz

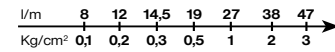

10 € 415,00 ■ box = 16 pz

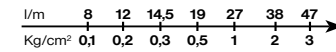

10 € 455,00 ■ box = 16 pz

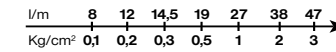

10 € 328,00 ■ box = 16 pz

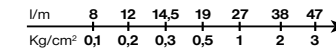

10 € 415,00 ■ box = 16 pz

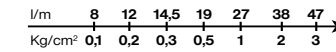

10 € 425,00 ■ box = 16 pz

962475

digit

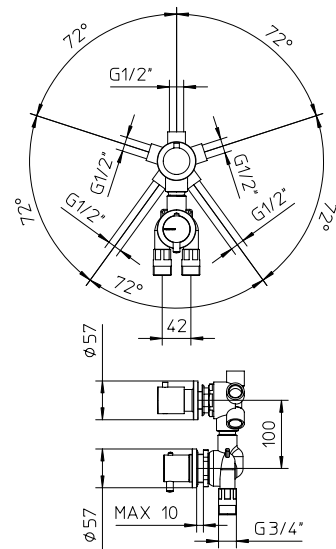

672475

riva

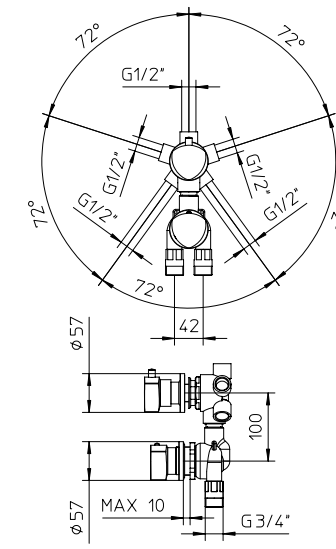

662475

kubik

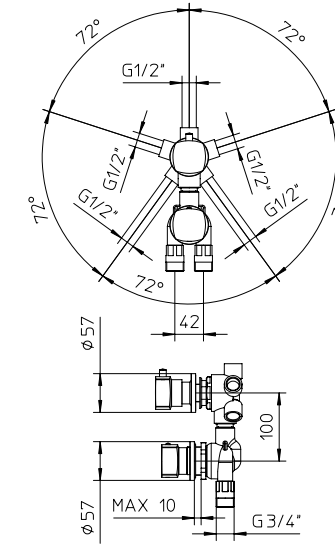

512475

retro

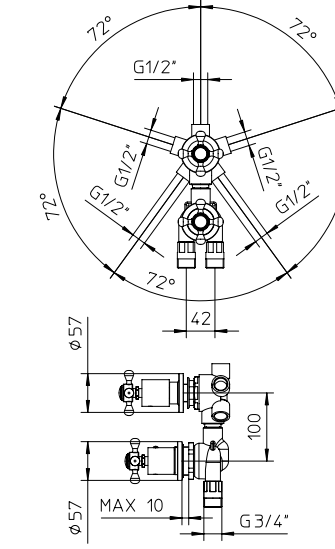

622475

formula

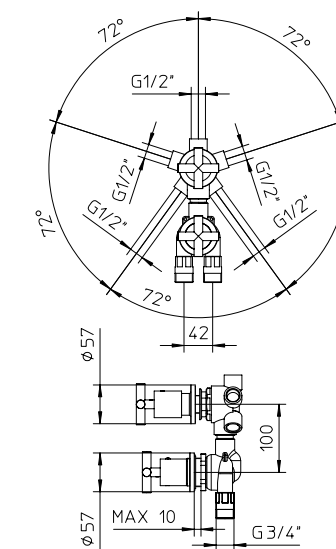

952475

maranello abs

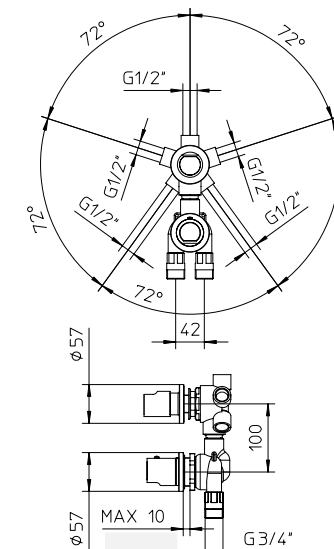

692475

oblique

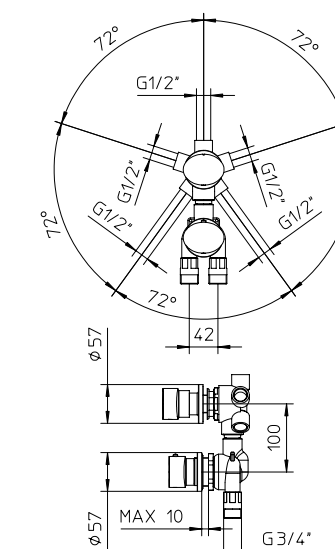

412475

track

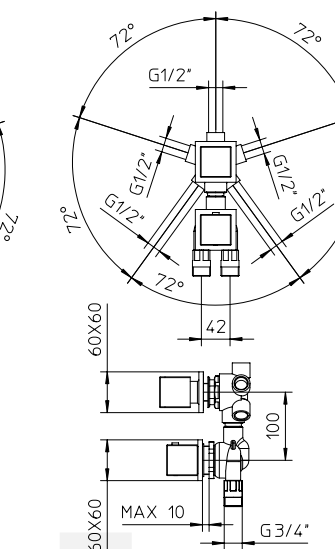

Miscelatore **termostatico** 1/2" da incasso completo per pannelli doccia con deviatore a **2 uscite** senza valvole di non ritorno.

Complete 1/2" concealed thermostatic mixer for shower with ceramic discs diverter, 2 outlets and stop function.

Mitigeur thermostatique 1/2" à encastrer complet pour douche avec inverseur à disques en céramique, 2 sorties et fonction de stop.

Komplett Unterputz 1/2" Thermostat-Mischer, mit Keramik 2-Wegeumsteller mit Stop-Position.

Mezclador termostático 1/2" empotrable completo para ducha con desviador a discos cerámicos, 2 salidas con stop.

Miscelatore **termostatico** 1/2" da incasso completo per pannelli doccia con deviatore a **2 uscite** senza valvole di non ritorno.

Complete 1/2" concealed thermostatic mixer for shower with ceramic discs diverter, 2 outlets and stop function.

Mitigeur thermostatique 1/2" à encastrer complet pour douche avec inverseur à disques en céramique, 2 sorties et fonction de stop.

Komplett Unterputz 1/2" Thermostat-Mischer, mit Keramik 2-Wegeumsteller mit Stop-Position.

Mezclador termostático 1/2" empotrable completo para ducha con desviador a discos cerámicos, 2 salidas con stop.

Miscelatore **termostatico** 1/2" da incasso completo per pannelli doccia con deviatore a **2 uscite** senza valvole di non ritorno.

Complete 1/2" concealed thermostatic mixer for shower with ceramic discs diverter, 2 outlets and stop function.

Mitigeur thermostatique 1/2" à encastrer complet pour douche avec inverseur à disques en céramique, 2 sorties et fonction de stop.

Komplett Unterputz 1/2" Thermostat-Mischer, mit Keramik 2-Wegeumsteller mit Stop-Position.

Mezclador termostático 1/2" empotrable completo para ducha con desviador a discos cerámicos, 2 salidas con stop.

Miscelatore **termostatico** 1/2" da incasso completo per pannelli doccia con deviatore a **2 uscite** senza valvole di non ritorno.

Complete 1/2" concealed thermostatic mixer for shower with ceramic discs diverter, 2 outlets and stop function.

Mitigeur thermostatique 1/2" à encastrer complet pour douche avec inverseur à disques en céramique, 2 sorties et fonction de stop.

Komplett Unterputz 1/2" Thermostat-Mischer, mit Keramik 2-Wegeumsteller mit Stop-Position.

Mezclador termostático 1/2" empotrable completo para ducha con desviador a discos cerámicos, 2 salidas con stop.

Miscelatore **monocomando** 1/2" da incasso completo per pannelli doccia con deviatore a **2 uscite** senza valvole di non ritorno.

Complete 1/2" concealed thermostatic mixer for shower with ceramic discs diverter, 2 outlets and stop function.

Mitigeur thermostatique 1/2" à encastrer complet pour douche avec inverseur à disques en céramique, 2 sorties et fonction de stop.

Komplett Unterputz 1/2" Thermostat-Mischer, mit Keramik 2-Wegeumsteller mit Stop-Position.

Mezclador termostático 1/2" empotrable completo para ducha con desviador a discos cerámicos, 2 salidas con stop.

Miscelatore **monocomando** 1/2" da incasso completo per pannelli doccia con deviatore a **2 uscite** senza valvole di non ritorno.

Complete 1/2" concealed thermostatic mixer for shower with ceramic discs diverter, 2 outlets and stop function.

Mitigeur thermostatique 1/2" à encastrer complet pour douche avec inverseur à disques en céramique, 2 sorties et fonction de stop.

Komplett Unterputz 1/2" Thermostat-Mischer, mit Keramik 2-Wegeumsteller mit Stop-Position.

Mezclador termostático 1/2" empotrable completo para ducha con desviador a discos cerámicos, 2 salidas con stop.

Miscelatore **monocomando** 1/2" da incasso completo per pannelli doccia con deviatore a **2 uscite** senza valvole di non ritorno.

Complete 1/2" concealed thermostatic mixer for shower with ceramic discs diverter, 2 outlets and stop function.

Mitigeur thermostatique 1/2" à encastrer complet pour douche avec inverseur à disques en céramique, 2 sorties et fonction de stop.

Komplett Unterputz 1/2" Thermostat-Mischer, mit Keramik 2-Wegeumsteller mit Stop-Position.

Mezclador termostático 1/2" empotrable completo para ducha con desviador a discos cerámicos, 2 salidas con stop.

Miscelatore **monocomando** 1/2" da incasso completo per pannelli doccia con deviatore a **2 uscite** senza valvole di non ritorno.

Complete 1/2" concealed thermostatic mixer for shower with ceramic discs diverter, 2 outlets and stop function.

Mitigeur thermostatique 1/2" à encastrer complet pour douche avec inverseur à disques en céramique, 2 sorties et fonction de stop.

Komplett Unterputz 1/2" Thermostat-Mischer, mit Keramik 2-Wegeumsteller mit Stop-Position.

Mezclador termostático 1/2" empotrable completo para ducha con desviador a discos cerámicos, 2 salidas con stop.

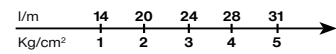

10 € 365,00 ■ box = 16 pz

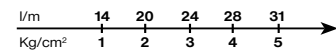

10 € 345,00 ■ box = 16 pz

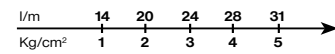

10 € 380,00 ■ box = 16 pz

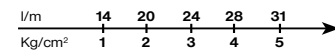

10 € 255,00 ■ box = 16 pz

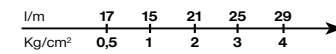

10 € 205,00 ■ box = 16 pz

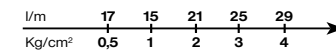

10 € 195,00 ■ box = 16 pz

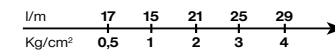

10 € 215,00 ■ box = 16 pz

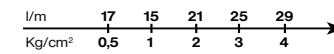

10 € 155,00 ■ box = 16 pz

3128V2

kubik

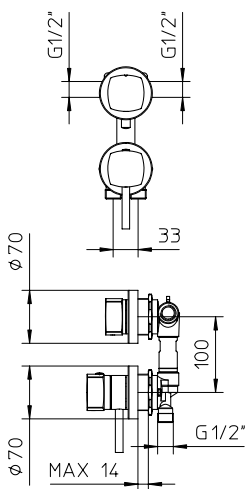

1328V2

idrotech

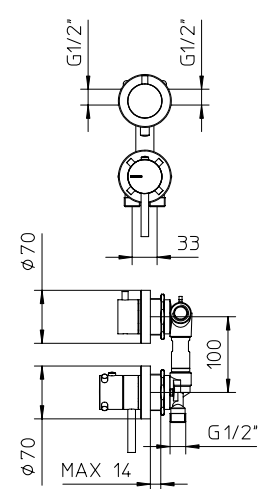

7528V2

formula

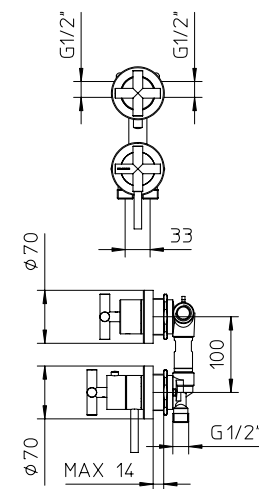

3927V2

proxima

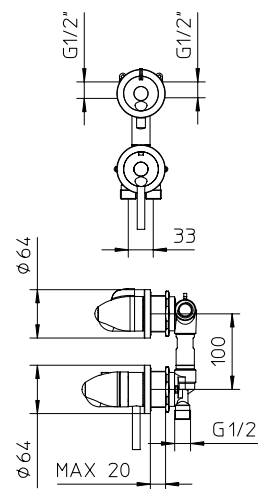

3028V2

kubik

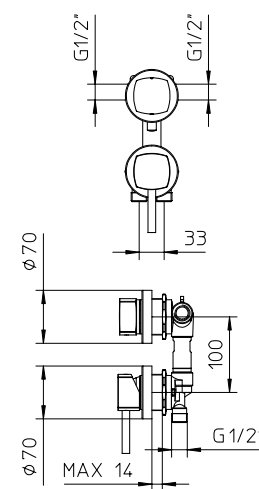

1228V2

idrotech

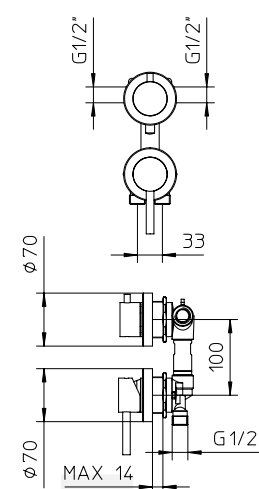

6228V2

formula

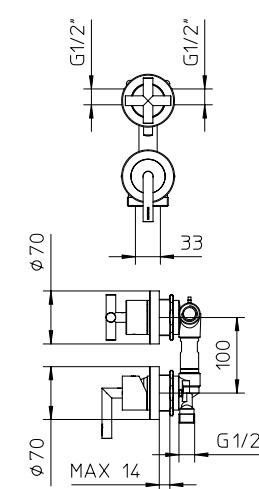

4027V2

proxima

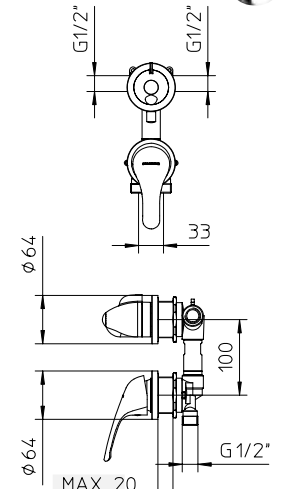

Miscelatore **termostatico** 1/2" da incasso completo per pannelli doccia con deviatore a **3 uscite** senza valvole di non ritorno.

Complete 1/2" concealed thermostatic mixer for shower with ceramic discs diverter, 3 outlets and stop function.

Mitigeur thermostatique 1/2" à encastrer complet pour douche avec inverseur à disques en céramique, 3 sorties et fonction de stop.

Komplett Unterputz 1/2" Thermostat-Mischer, mit Keramik 3-Wegeumsteller mit Stop-Position.

Mezclador termostático 1/2" empotrable completo para ducha con desviador a discos cerámicos, 3 salidas con stop.

Miscelatore **termostatico** 1/2" da incasso completo per pannelli doccia con deviatore a **3 uscite** senza valvole di non ritorno.

Complete 1/2" concealed thermostatic mixer for shower with ceramic discs diverter, 3 outlets and stop function.

Mitigeur thermostatique 1/2" à encastrer complet pour douche avec inverseur à disques en céramique, 3 sorties et fonction de stop.

Komplett Unterputz 1/2" Thermostat-Mischer, mit Keramik 3-Wegeumsteller mit Stop-Position.

Mezclador termostático 1/2" empotrable completo para ducha con desviador a discos cerámicos, 3 salidas con stop.

Miscelatore **termostatico** 1/2" da incasso completo per pannelli doccia con deviatore a **3 uscite** senza valvole di non ritorno.

Complete 1/2" concealed thermostatic mixer for shower with ceramic discs diverter, 3 outlets and stop function.

Mitigeur thermostatique 1/2" à encastrer complet pour douche avec inverseur à disques en céramique, 3 sorties et fonction de stop.

Komplett Unterputz 1/2" Thermostat-Mischer, mit Keramik 3-Wegeumsteller mit Stop-Position.

Mezclador termostático 1/2" empotrable completo para ducha con desviador a discos cerámicos, 3 salidas con stop.

Miscelatore **termostatico** 1/2" da incasso completo per pannelli doccia con deviatore a **3 uscite** senza valvole di non ritorno.

Complete 1/2" concealed thermostatic mixer for shower with ceramic discs diverter, 3 outlets and stop function.

Mitigeur thermostatique 1/2" à encastrer complet pour douche avec inverseur à disques en céramique, 3 sorties et fonction de stop.

Komplett Unterputz 1/2" Thermostat-Mischer, mit Keramik 3-Wegeumsteller mit Stop-Position.

Mezclador termostático 1/2" empotrable completo para ducha con desviador a discos cerámicos, 3 salidas con stop.

Miscelatore **monocomando** 1/2" da incasso completo per pannelli doccia con deviatore a **3 uscite** senza valvole di non ritorno.

Complete 1/2" concealed thermostatic mixer for shower with ceramic discs diverter, 3 outlets and stop function.

Mitigeur thermostatique 1/2" à encastrer complet pour douche avec inverseur à disques en céramique, 3 sorties et fonction de stop.

Komplett Unterputz 1/2" Thermostat-Mischer, mit Keramik 3-Wegeumsteller mit Stop-Position.

Mezclador termostático 1/2" empotrable completo para ducha con desviador a discos cerámicos, 3 salidas con stop.

Miscelatore **monocomando** 1/2" da incasso completo per pannelli doccia con deviatore a **3 uscite** senza valvole di non ritorno.

Complete 1/2" concealed thermostatic mixer for shower with ceramic discs diverter, 3 outlets and stop function.

Mitigeur thermostatique 1/2" à encastrer complet pour douche avec inverseur à disques en céramique, 3 sorties et fonction de stop.

Komplett Unterputz 1/2" Thermostat-Mischer, mit Keramik 3-Wegeumsteller mit Stop-Position.

Mezclador termostático 1/2" empotrable completo para ducha con desviador a discos cerámicos, 3 salidas con stop.

Miscelatore **monocomando** 1/2" da incasso completo per pannelli doccia con deviatore a **3 uscite** senza valvole di non ritorno.

Complete 1/2" concealed thermostatic mixer for shower with ceramic discs diverter, 3 outlets and stop function.

Mitigeur thermostatique 1/2" à encastrer complet pour douche avec inverseur à disques en céramique, 3 sorties et fonction de stop.

Komplett Unterputz 1/2" Thermostat-Mischer, mit Keramik 3-Wegeumsteller mit Stop-Position.

Mezclador termostático 1/2" empotrable completo para ducha con desviador a discos cerámicos, 3 salidas con stop.

Miscelatore **monocomando** 1/2" da incasso completo per pannelli doccia con deviatore a **3 uscite** senza valvole di non ritorno.

Complete 1/2" concealed thermostatic mixer for shower with ceramic discs diverter, 3 outlets and stop function.

Mitigeur thermostatique 1/2" à encastrer complet pour douche avec inverseur à disques en céramique, 3 sorties et fonction de stop.

Komplett Unterputz 1/2" Thermostat-Mischer, mit Keramik 3-Wegeumsteller mit Stop-Position.

Mezclador termostático 1/2" empotrable completo para ducha con desviador a discos cerámicos, 3 salidas con stop.

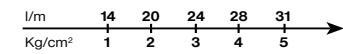

10 € 380,00 ■ box = 16 pz

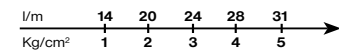

10 € 360,00 ■ box = 16 pz

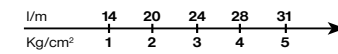

10 € 395,00 ■ box = 16 pz

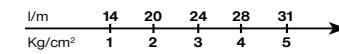

10 € 270,00 ■ box = 16 pz

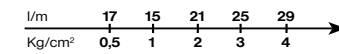

10 € 220,00 ■ box = 16 pz

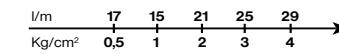

10 € 210,00 ■ box = 16 pz

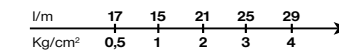

10 € 230,00 ■ box = 16 pz

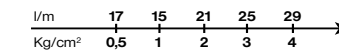

10 € 170,00 ■ box = 16 pz

3128V3

kubik

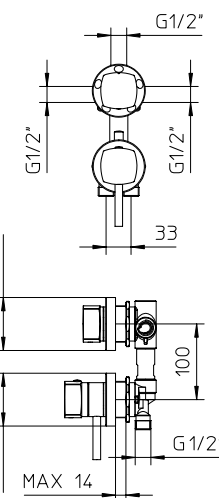

1328V3

idrotech

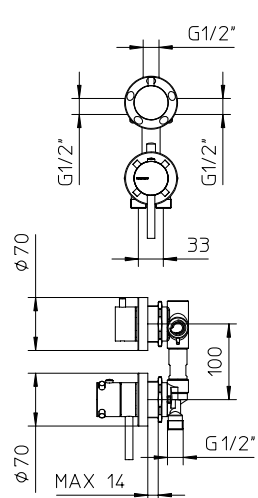

7528V3

formula

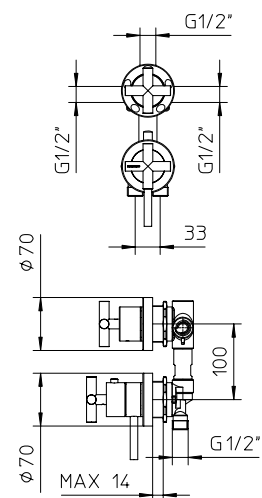

3927V3

proxima

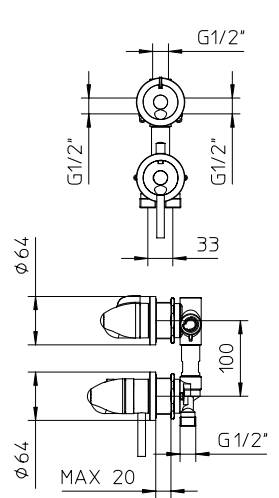

3028V3

kubik

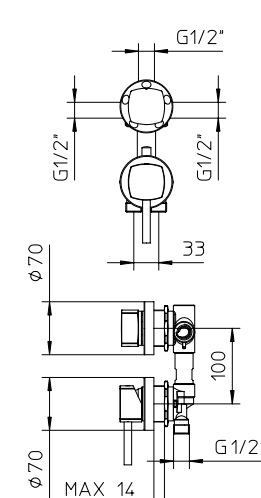

1228V3

idrotech

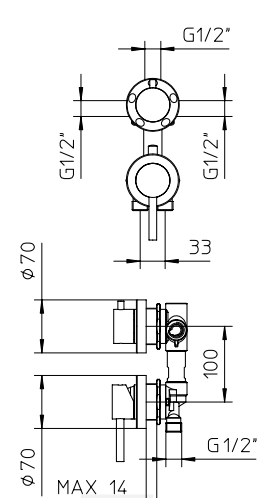

6228V3

formula

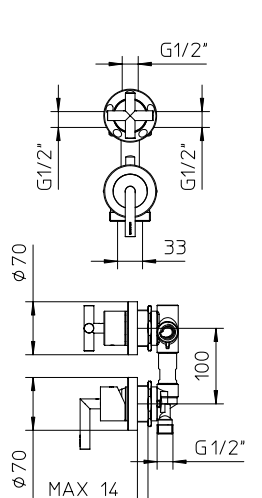

4027V3

proxima

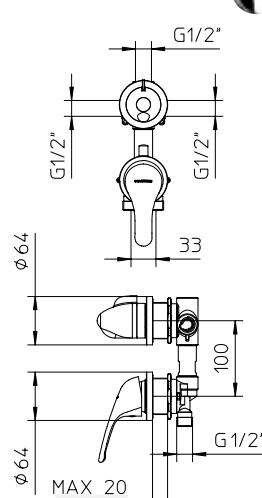

Miscelatore **termostatico** 1/2" da incasso completo per pannelli doccia con deviatore a **5 uscite** senza valvole di non ritorno.

Complete 1/2" concealed thermostatic mixer for shower with ceramic discs diverter, 5 outlets and stop function.

Mitigeur thermostatique 1/2" à encastrer complet pour douche avec inverseur à disques en céramique, 5 sorties et fonction de stop.

Komplett Unterputz 1/2" Thermostat-Mischer, mit Keramik 5-Wegeumsteller mit Stop-Position.

Mezclador termostático 1/2" empotrable completo para ducha con desviador a discos cerámicos, 5 salidas con stop.

Miscelatore **termostatico** 1/2" da incasso completo per pannelli doccia con deviatore a **5 uscite** senza valvole di non ritorno.

Complete 1/2" concealed thermostatic mixer for shower with ceramic discs diverter, 5 outlets and stop function.

Mitigeur thermostatique 1/2" à encastrer complet pour douche avec inverseur à disques en céramique, 5 sorties et fonction de stop.

Komplett Unterputz 1/2" Thermostat-Mischer, mit Keramik 5-Wegeumsteller mit Stop-Position.

Mezclador termostático 1/2" empotrable completo para ducha con desviador a discos cerámicos, 5 salidas con stop.

Miscelatore **termostatico** 1/2" da incasso completo per pannelli doccia con deviatore a **5 uscite** senza valvole di non ritorno.

Complete 1/2" concealed thermostatic mixer for shower with ceramic discs diverter, 5 outlets and stop function.

Mitigeur thermostatique 1/2" à encastrer complet pour douche avec inverseur à disques en céramique, 5 sorties et fonction de stop.

Komplett Unterputz 1/2" Thermostat-Mischer, mit Keramik 5-Wegeumsteller mit Stop-Position.

Mezclador termostático 1/2" empotrable completo para ducha con desviador a discos cerámicos, 5 salidas con stop.

Miscelatore **termostatico** 1/2" da incasso completo per pannelli doccia con deviatore a **5 uscite** senza valvole di non ritorno.

Complete 1/2" concealed thermostatic mixer for shower with ceramic discs diverter, 5 outlets and stop function.

Mitigeur thermostatique 1/2" à encastrer complet pour douche avec inverseur à disques en céramique, 5 sorties et fonction de stop.

Komplett Unterputz 1/2" Thermostat-Mischer, mit Keramik 5-Wegeumsteller mit Stop-Position.

Mezclador termostático 1/2" empotrable completo para ducha con desviador a discos cerámicos, 5 salidas con stop.

Miscelatore **monocomando** 1/2" da incasso completo per pannelli doccia con deviatore a **5 uscite** senza valvole di non ritorno.

Complete 1/2" concealed thermostatic mixer for shower with ceramic discs diverter, 5 outlets and stop function.

Mitigeur thermostatique 1/2" à encastrer complet pour douche avec inverseur à disques en céramique, 5 sorties et fonction de stop.

Komplett Unterputz 1/2" Thermostat-Mischer, mit Keramik 5-Wegeumsteller mit Stop-Position.

Mezclador termostático 1/2" empotrable completo para ducha con desviador a discos cerámicos, 5 salidas con stop.

Miscelatore **monocomando** 1/2" da incasso completo per pannelli doccia con deviatore a **5 uscite** senza valvole di non ritorno.

Complete 1/2" concealed thermostatic mixer for shower with ceramic discs diverter, 5 outlets and stop function.

Mitigeur thermostatique 1/2" à encastrer complet pour douche avec inverseur à disques en céramique, 5 sorties et fonction de stop.

Komplett Unterputz 1/2" Thermostat-Mischer, mit Keramik 5-Wegeumsteller mit Stop-Position.

Mezclador termostático 1/2" empotrable completo para ducha con desviador a discos cerámicos, 5 salidas con stop.

Miscelatore **monocomando** 1/2" da incasso completo per pannelli doccia con deviatore a **5 uscite** senza valvole di non ritorno.

Complete 1/2" concealed thermostatic mixer for shower with ceramic discs diverter, 5 outlets and stop function.

Mitigeur thermostatique 1/2" à encastrer complet pour douche avec inverseur à disques en céramique, 5 sorties et fonction de stop.

Komplett Unterputz 1/2" Thermostat-Mischer, mit Keramik 5-Wegeumsteller mit Stop-Position.

Mezclador termostático 1/2" empotrable completo para ducha con desviador a discos cerámicos, 5 salidas con stop.

Miscelatore **monocomando** 1/2" da incasso completo per pannelli doccia con deviatore a **5 uscite** senza valvole di non ritorno.

Complete 1/2" concealed thermostatic mixer for shower with ceramic discs diverter, 5 outlets and stop function.

Mitigeur thermostatique 1/2" à encastrer complet pour douche avec inverseur à disques en céramique, 5 sorties et fonction de stop.

Komplett Unterputz 1/2" Thermostat-Mischer, mit Keramik 5-Wegeumsteller mit Stop-Position.

Mezclador termostático 1/2" empotrable completo para ducha con desviador a discos cerámicos, 5 salidas con stop.

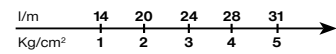

10 € 395,00 ■ box = 16 pz

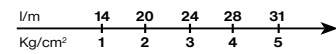

10 € 375,00 ■ box = 16 pz

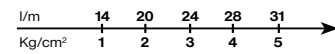

10 € 410,00 ■ box = 16 pz

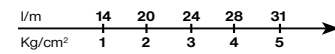

10 € 285,00 ■ box = 16 pz

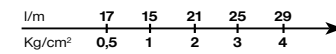

10 € 235,00 ■ box = 16 pz

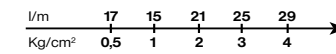

10 € 225,00 ■ box = 16 pz

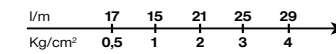

10 € 245,00 ■ box = 16 pz

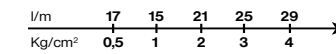

10 € 185,00 ■ box = 16 pz

3128V5

kubik

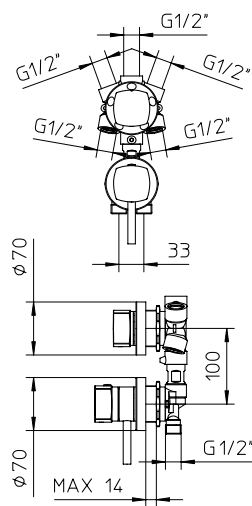

1328V5

idrotech

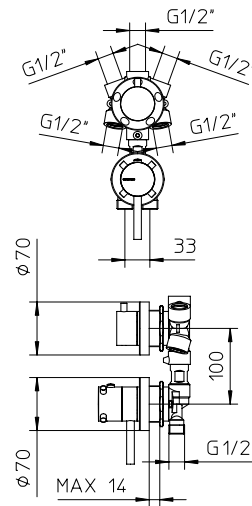

7528V5

formula

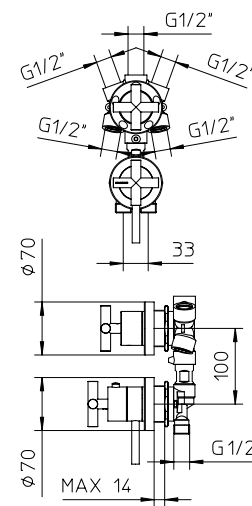

3927V5

proxima

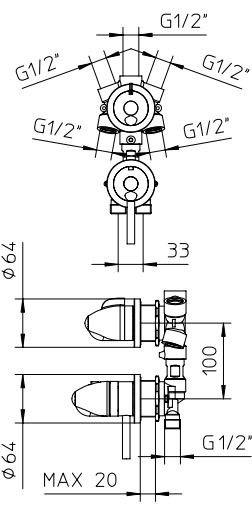

3028V5

kubik

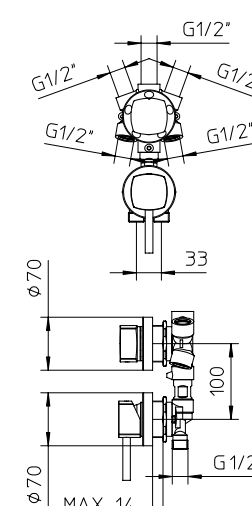

1228V5

idrotech

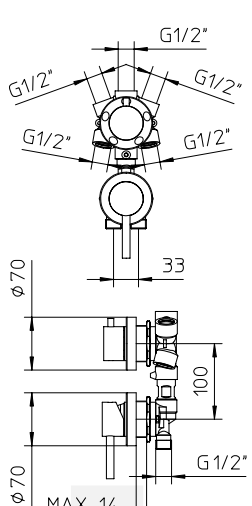

6228V5

formula

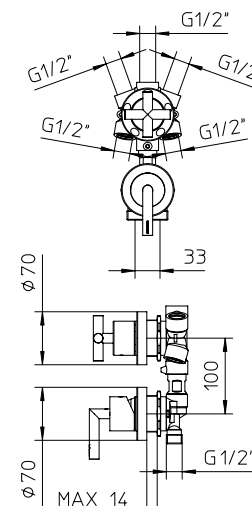

4027V5

proxima

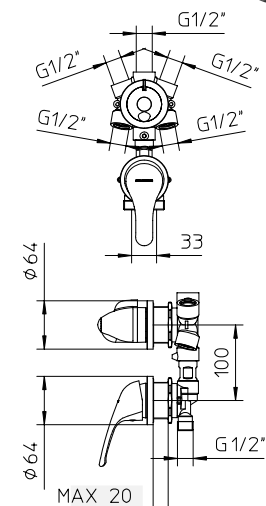

pannelli doccia

Miscelatore **monocomando** completo per pannello doccia con entrate acqua verticali e fissaggio 'Long-Fix'.

Complete single lever mixer shower panel, vertical inlets. Fixing system "Long Fix".

Mitigeur monocommande complet pour paroi de douche, arrivées d'eau verticales, système de fixation "Long Fix".

Komplett Einhebelmischer für Duschepaneel, Senkrechten Wassereinlauf. Montage mit, Long Fix' Systeme.

Mezclador monomando completo para columna de ducha. Connexiones verticales, montaje con sistema Long Fix. Montaje con sistema 'Long Fix'.

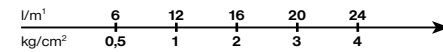

10 € 84,00 ■ box = 0 pz

4027V0

proxima



Miscelatore **monocomando** completo per pannello doccia con entrate acqua verticali e fissaggio 'Long-Fix'.

Complete single lever mixer shower panel, vertical inlets. Fixing system "Long Fix".

Mitigeur monocommande complet pour paroi de douche, arrivées d'eau verticales, système de fixation "Long Fix".

Komplett Einhebelmischer für Duschepaneel, Senkrechten Wassereinlauf. Montage mit, Long Fix' Systeme.

Mezclador monomando completo para columna de ducha. Connexiones verticales, montaje con sistema Long Fix. Montaje con sistema 'Long Fix'.

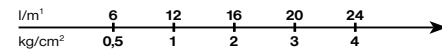

10 € 99,00 ■ box = 0 pz

1228V0

idrotech



Deviatore, 1 entrata M 1/2" e 2 uscite M 1/2" a pulsante con blocco manuale per pannello doccia.

Diverter, one inlet M 1/2" and two outlets M 1/2", pushbutton system with block position for shower panel.

Inverseur, 1 arrivée 1/2" et 2 sorties M 1/2" à bouton-poussoir avec position blocage pour paroi de douche.

Zwei-Wege Umsteller, 1 Wassereinlauf und 2 Ausgänge 1/2" Aussengewinde, mit Blockierung für Duschpaneel.

Distribuidor, 1 entrada M 1/2" y 2 salidas M 1/2" con boton, bloque manual, para panel ducha.

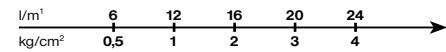

10 € 49,00 ■ box = 0 pz

441072

Miscelatore **termostatico** completo per pannello doccia con entrate acqua verticali e fissaggio 'Long-Fix'.

Complete thermostatic mixer shower panel, vertical inlets. Fixing system "Long Fix".

Mitigeur thermostatique complet pour paroi de douche, arrivées d'eau verticales, système de fixation "Long Fix".

Komplett Thermostat-Mischer für Duschepaneel, Senkrechten Wassereinlauf. Montage mit, Long Fix' Systeme.

Mezclador termostático completo para columna de ducha. Connexiones verticales, montaje con sistema Long Fix. Montaje con sistema 'Long Fix'.

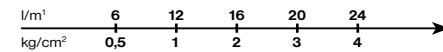

10 € 182,00 ■ box = 0 pz

3927V0

proxima



Miscelatore **termostatico** completo per pannello doccia con entrate acqua verticali e fissaggio 'Long-Fix'.

Complete thermostatic mixer shower panel, vertical inlets. Fixing system "Long Fix".

Mitigeur thermostatique complet pour paroi de douche, arrivées d'eau verticales, système de fixation "Long Fix".

Komplett Thermostat-Mischer für Duschepaneel, Senkrechten Wassereinlauf. Montage mit, Long Fix' Systeme.

Mezclador termostático completo para columna de ducha. Connexiones verticales, montaje con sistema Long Fix. Montaje con sistema 'Long Fix'.

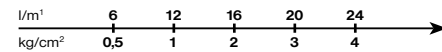

10 € 299,00 ■ box = 0 pz

1328V0

idrotech



Deviatore a tre vie con dischi in ceramica per pannello doccia. Fissaggio "Long-Fix".

Three-ways diverter, ceramic disc operated for shower panel. Fixing system "Long Fix".

Inverseur à trois voies, cartouche en céramique, pour paroi de douche, système de fixation "Long Fix".

Drei-Wege Umsteller mit keramischem Scheiben für Duschpaneel, montage mit "Long Fix" Systeme.

Distribuidor a tres vias, con cartucho cerámico para columna de ducha, montaje con sistema "Long Fix".

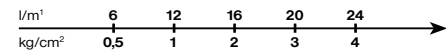

10 € 99,00 ■ box = 0 pz

832703

Batteria per bordo vasca 2 fori con miscelatore monocomando e deviatore.

Deck mounted bath-shower mixer 2 hole, complete with diverter.

Mélangeur à 2 trous pour bain-douche avec inverseur.

Batterie für Wannenfüllbatterie mit Umsteller.

Bateria de sobreponer para bañera 2 agujeros con mezclador monomando y distribuidor.

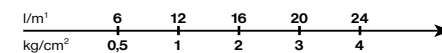

10 € 159,00 ■ box = 16 pz

401087

proxima

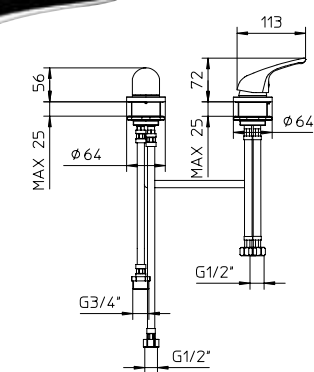
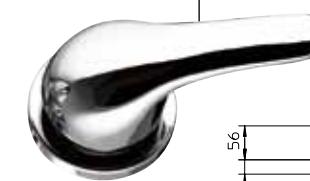

Batteria per bordo vasca 2 fori con miscelatore monocomando e deviatore.

Deck mounted bath-shower mixer 2 hole, complete with diverter.

Mélangeur à 2 trous pour bain-douche avec inverseur.

Batterie für Wannenfüllbatterie mit Umsteller.

Bateria de sobreponer para bañera 2 agujeros con mezclador monomando y distribuidor.

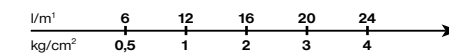

10 € 129,00 ■ box = 16 pz

401088

proxima

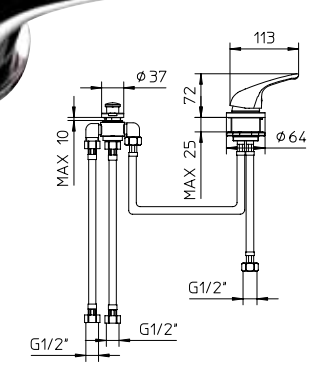

Batteria per bordo vasca 2 fori con miscelatore monocomando e deviatore.

Deck mounted bath-shower mixer 2 hole, complete with diverter.

Mélangeur à 2 trous pour bain-douche avec inverseur.

Batterie für Wannenfüllbatterie mit Umsteller.

Bateria de sobreponer para bañera 2 agujeros con mezclador monomando y distribuidor.

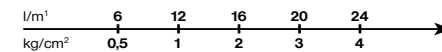

10 € 199,00 ■ box = 16 pz

121081

idrotech

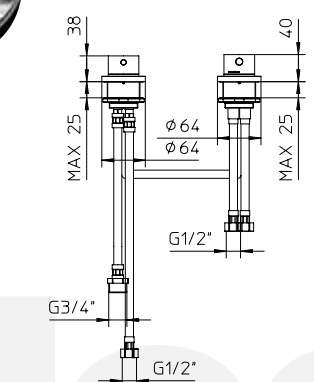

Batteria per bordo vasca 2 fori con miscelatore monocomando e deviatore.

Deck mounted bath-shower mixer 2 hole, complete with diverter.

Mélangeur à 2 trous pour bain-douche avec inverseur.

Batterie für Wannenfüllbatterie mit Umsteller.

Bateria de sobreponer para bañera 2 agujeros con mezclador monomando y distribuidor.

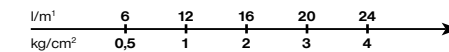

10 € 149,00 ■ box = 16 pz

121083

idrotech

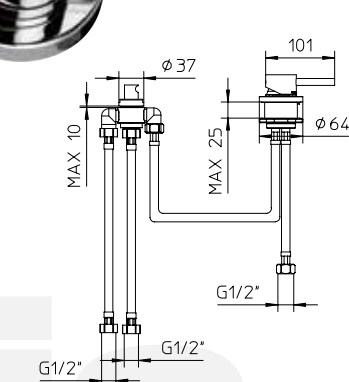

bordovasca